

SSH

S & M-GROUP 316 STAINLESS STEEL END SUCTION PUMPS

BOMBAS DE SUCCIÓN FINAL DE 316 ACERO INOXIDABLE GRUPO-M Y S



A FULL RANGE OF PRODUCT FEATURES, UNA GAMA TOTAL DE CARACTERÍSTICAS DEL PRODUCTO

Superior Materials of Construction: AISI Type 316L stainless steel pump parts for reduced corrosion and improved strength and ductility.

Frame Mounted Design: Flexibility of installation and driver arrangements.

Back Pull-Out Design: Simplifies maintenance when used with spacer type coupling.

Cast Iron Power Frame: Rigidly supported, grease lubricated ball bearing assembly.

Mechanical Seal: Standard John Crane Type 21 mechanical seal.

Drive Motors: Standard NEMA design T-frame or JM motors in single or three phase.

Suction and Discharge Flanges: Mate with ANSI class 150 flanges.

Close-Coupled Design: Compact design saves space and simplifies maintenance.

Materiales Superiores de Construcción: Partes de la bomba de acero inoxidable AISI Tipo 316L para corrosión reducida y fuerza y ductilidad mejoradas.

Diseño de Armazón Montado: Flexibilidad de instalación y colocación del motor.

Diseño de Extracción Trasera: Simplifica el mantenimiento cuando se usa con el acople tipo espaciador.

Armazón del Motor de Hierro Fundido: Rígidamente soportado, con ensamblaje de balineras de bolas lubricadas con grasa .

Sello Mecánico: Sello mecánico estándar John Crane Tipo 21.

Motores de Accionamiento: Motores de armazón-T NEMA estándar unifásicos o trifásicos.

Bridas de Succión y Descarga: Acoplan con bridas ANSI clase 150.

Diseño de Acople Cerrado: El diseño compacto ahorra espacio y simplifica el mantenimiento.

PERFORMANCE COVERAGE, 3500 AND 1750 RPM ALCANCE DE FUNCIONAMIENTO, 3500 Y 1750 RPM

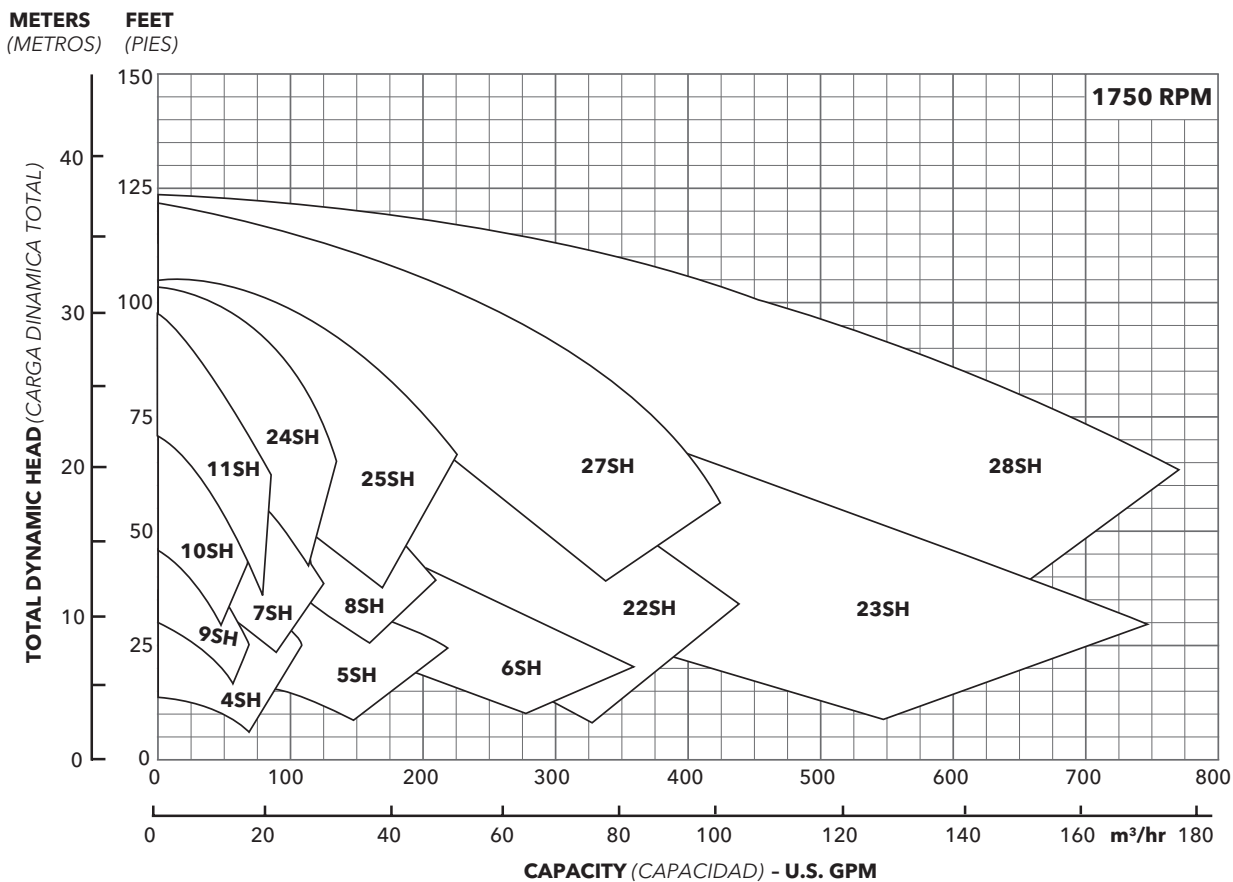
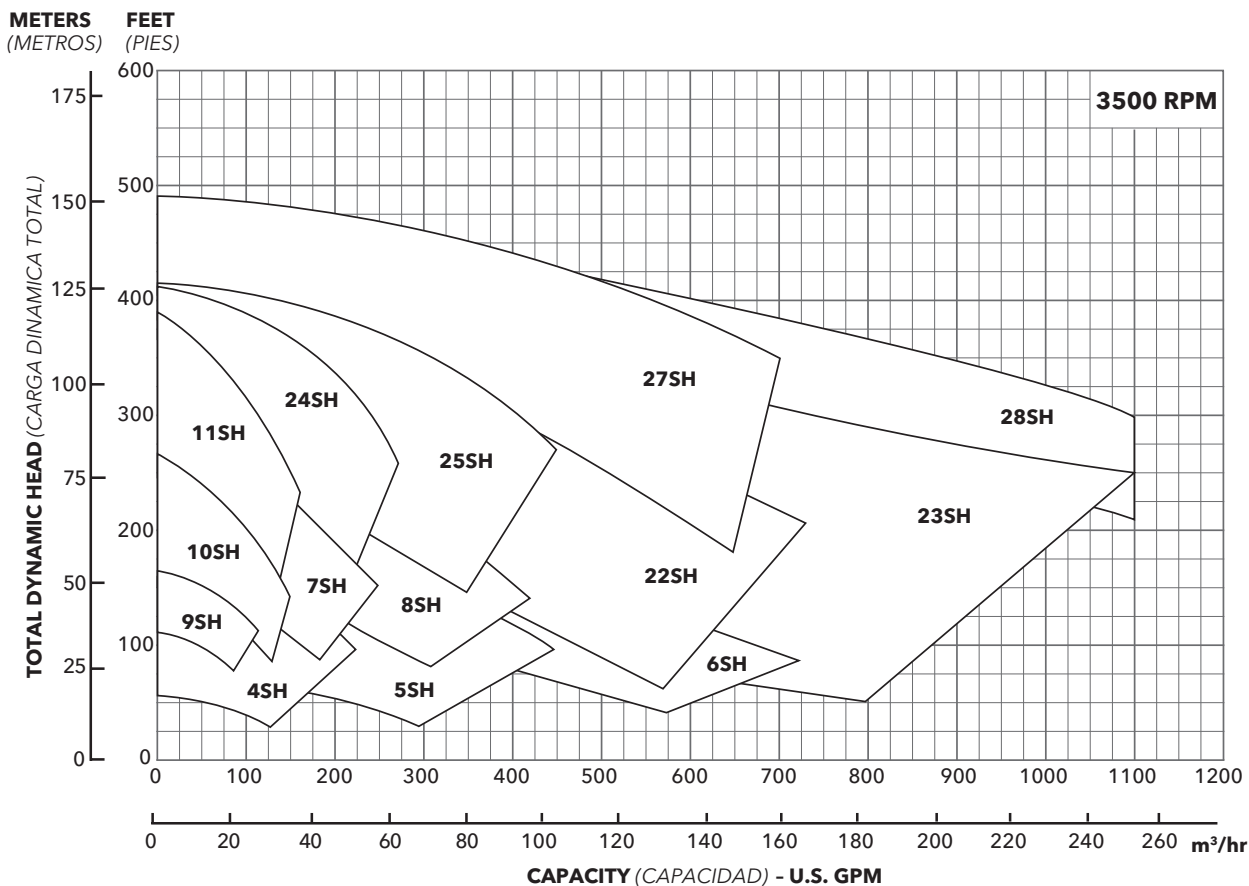

SSH S/M-GROUP NUMBERING SYSTEM SISTEMA DE NUMERACIÓN DEL GRUPO-S/M SSH

Example Product Code, Ejemplo Código del Producto

24 SH 1 Q 1 2 A 0 R

Casing Rotation, Optional

R = 3 o'clock B = 6 o'clock L = 9 o'clock

NOTE: Rotation when viewed from suction end of pump. Standard discharge position is 12 o'clock.

Mechanical Seals and O-Ring

0 = Pre-engineered standard

For optional mechanical seal modify catalog order no. with seal code listed below.

Rotación de la cubierta, opcional

R = 3 hora B = 6 hora L = 9 hora

NOTA: Rotación cuando está visto del extremo de la succión de la bomba. La posición estándar de la descarga es las 12.

Sello Mecánico y Anillo 'O'

0 = Estándar aprobado. Para sello mecánico opcional modificar el número de orden del catálogo con el código del sello anotado abajo.

John Crane Type 21 Mechanical Seal, Sello Mecánico John Crane Tipo 21

Seal Code, Código del Sello	Rotary, Rotativo	Stationary, Estacionario	Elastomers, Elastómeros	Metal Parts, Partes Metálicas	Part No., Pieza Número	
					180-210 Frames, Armazones	250-360 Frames, Armazones
0	Carbon	Sil-Carb	Viton	316 SS, 316 Acero inoxidable	10K27	10K45
2			EPR		10K19	10K20
5	Sil-Carb	Sil-Carb	Viton		10K64	10K65

Impeller Option Code - For optional impeller diameters modify catalog order no. with impeller code listed below. Select optional impeller diameter from pump performance curve.

NOTE: For trimmed impellers, use T for impeller code.

Código del Impulsor Opcional - Para diámetros del impulsor opcional modificar el número de orden del catálogo con el código del impulsor anotado abajo. Seleccionar el diámetro del impulsor opcional de la curva de funcionamiento de la bomba.

NOTA: Para los impulsores cortados, utilice T para el código del impulsor.

Impeller Code, Código del impulsor	Pump Size, Tamaño de la Bomba													
	9SH 1 x 2-6 Dia.	10SH 1 x 2-8 Dia.	11SH 1 x 2-10 Dia.	4SH 1 1/2 x 2 1/2-6 Dia.	7SH 1 1/2 x 2 1/2-8 Dia.	5SH 2 x 2 1/2-6 Dia.	8SH 2 x 2 1/2-8 Dia.	*6SH 2 1/2 x 3-6 Dia.	*22SH 2 1/2 x 3-8 Dia.	*23SH 3 x 4-8 Dia.	24SH 1 1/2 x 2 1/2- 10 Dia.	25SH 2 x 2 1/2 -10 Dia.	*27SH 2 1/2 x 3 -10 Dia.	*28SH 3 x 4-10 Dia.
A	6 3/8	8 27/64	10 3/32	6 3/4	8 1/4	6 1/8	8 1/4	7 5/16	9 1/16	9 1/16	9 1/8	9 1/8	10 3/8	10 5/8
B	6 7/16	8 1/16	9 17/32	6 3/8	7 13/16	6 7/16	7 3/4	7 1/8	8 3/4	8 1/16	9 1/2	9 1/2	9 15/16	10 1/4
C	5 1/16	7 1/16	9 1/8	6 1/16	7	5 13/16	7 1/2	6 13/16	8 1/2	8 7/16	9 3/16	9 1/8	9 1/8	9 13/16
D	5 3/8	7 3/8	8 3/4	5 5/8	6 3/4	5 1/2	7 1/16	6 1 1/16	8 1/4	8 1/16	8 3/8	8 3/8	9 1/4	9 1/8
E		7 1/8		5 5/8	6 1/16	5 1/2	6 3/8	7 1/8	7 1/16	8 1/16	8 3/8	8 3/8	8 3/4	9 1/8
F				4 1 1/16	6 1/8	4 3/16	6 1/16	6 1/16	7 1/2	7 1/2	8 1/4	7 13/16		8 1 1/16
G				4 3/8		4 1/16		5 3/8	7 1/8	7 1/8		7 1 1/16		
H				4 3/16					6 1 1/16	6 7/8				
J									6 1/2	6 1/2				
K										6				
L										5 1/2				

NOTE: Impellers will be trimmed in 1/16" increments only. If you are ordering a trim within 1/16" of the standard impeller, you will receive the standard impeller trim.

* Indicates impellers that can be trimmed

NOTA: Los impulsores serán cortados en 1/16" incrementos solamente. Si usted está pidiendo un ajuste dentro de 1/16" del impulsor estándar, usted recibirá el ajuste estándar del impulsor.

* Indica los impulsores que pueden ser cortados

Motor Enclosure, Caja del motor

1 = ODP

2 = TEFC

3 = Explosion Proof, Prueba de explosiones

4 = 3PH, ODP PE

5 = 3PH, TE PE

6 = 3PH, XP PE

7 = Wash down, Lavado

8 = 3PH, WD PE

9 = 1PH, ODP PE

A = 1PH, TE PE

Motor Voltage, Voltaje del motor

1 = 115/208-230

3 = 230

5 = 208-230/460

6 = 460

7 = 575

X = Non Std.

HP Rating, Potencia nominal, HP

C = 1/2

F = 1.5

J = 5

M = 15

Q = 30

T = 60

D = .75

G = 2

K = 7.5

N = 20

R = 40

U = 75

E = 1

H = 3

L = 10

P = 25

S = 50

V = 100

Driver: Hertz/Pole/RPM, Fuerza motriz: Hertz/Polos/RPM

1 = 60/3500/1

3 = 60/1750/1

5 = 50/2900/1

2 = 60/3500/3

4 = 60/1750/3

6 = 50/2900/3

Material

SH = 316L Stainless steel, Acero inoxidable

Pump Size, Tamaño de la Bomba

9 = 1 x 2 - 6

4 = 1 1/2 x 2 1/2 - 6

8 = 2 x 2 1/2 - 8

10 = 1 x 2 - 8

7 = 1 1/2 x 2 1/2 - 8

6 = 2 1/2 x 3 - 6

11 = 1 x 2 - 10

5 = 2 x 2 1/2 - 6

22 = 2 1/2 x 3 - 8

23 = 3 x 4 - 8

24 = 1 1/2 x 2 1/2 - 10

25 = 2 x 2 1/2 - 10

27 = 2 1/2 x 3 - 10

28 = 3 x 4 - 10

Frame Options, Opciones de mando

Substitute, Substituto	Description, Descripción
FRM2	7/8" Imp. Bore, Diámetro interior del impulsor 7/8"
FRM3	1 1/4" Imp. Bore, Diámetro interior del impulsor 1 1/4"

NOTE: Not all combinations of motor, impeller and seal options are available for every pump model. Please check with GWT on non-cataloged numbers.

NOTA: No todas las combinaciones de las opciones de motor, impulsor y sello están disponibles para cada modelo de bombas. Por favor verifique con GWT en los números no catalogados.

Commercial Water

PERFORMANCE CURVES - 60 HZ, 3500 RPM CURVAS DE FUNCIONAMIENTO - 60 HZ, 3500 RPM

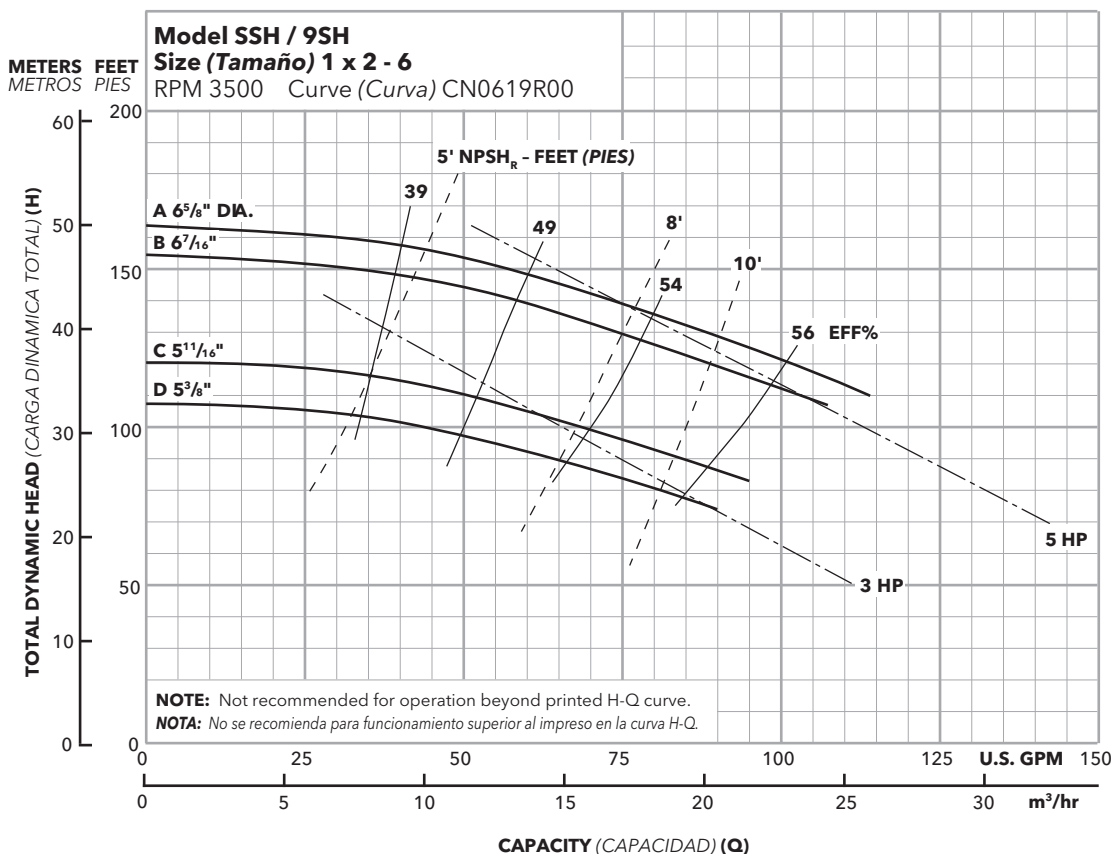

Optional Impeller, Impulsor Opcional		
Impeller Code, Código del Impulsor	Dia., Diá.	Standard HP Rating, Estándar HP Potencia
A	6 ⁵ / ₈ "	5
B	6 ⁷ / ₁₆ "	5
C	5 ¹¹ / ₁₆ "	3
D	5 ³ / ₈ "	3

NOTE: Pump will pass a sphere to 1/8" diameter.

NOTA: La bomba pasará una esfera a 1/8" diámetro.

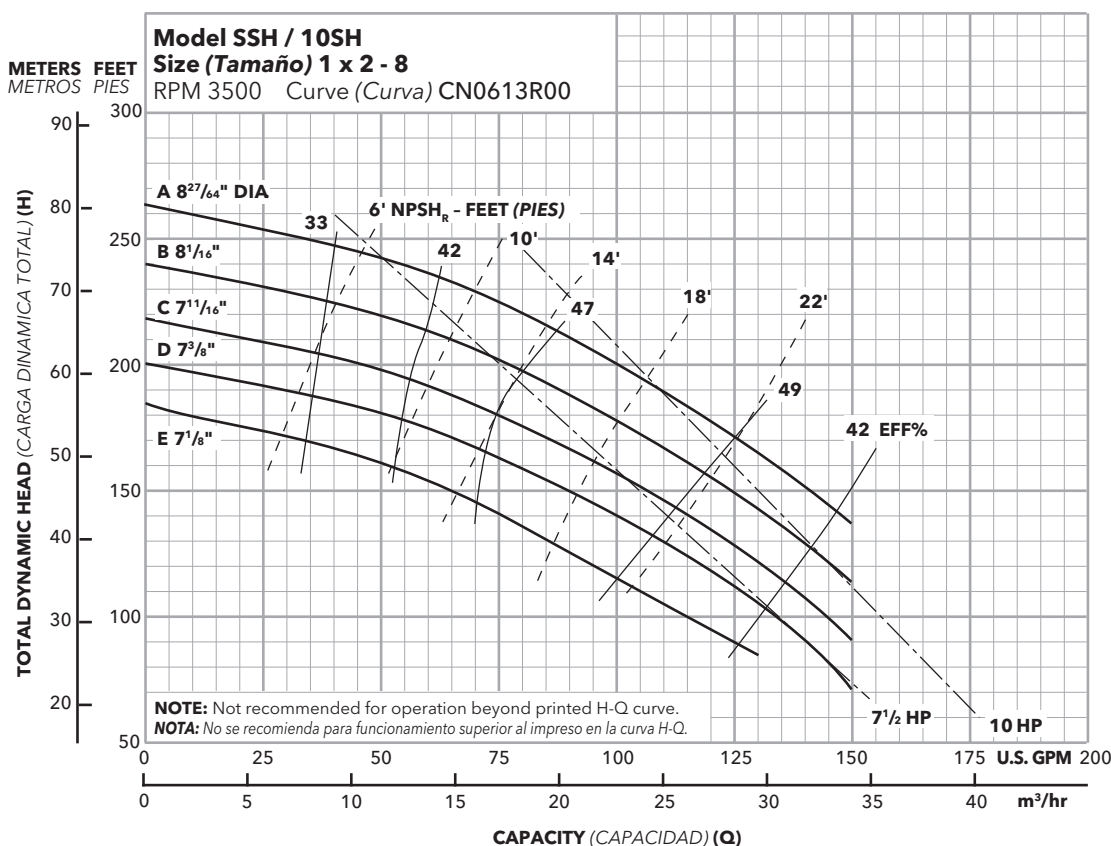

Optional Impeller, Impulsor Opcional		
Impeller Code, Código del Impulsor	Dia., Diá.	Standard HP Rating, Estándar HP Potencia
A	8 ²⁷ / ₆₄ "	10
B	8 ¹ / ₁₆ "	10
C	7 ¹¹ / ₁₆ "	7 ¹ / ₂
D	7 ³ / ₈ "	7 ¹ / ₂
E	7 ¹ / ₈ "	7 ¹ / ₂

NOTE: Pump will pass a sphere to 1/8" diameter.

NOTA: La bomba pasará una esfera a 1/8" diámetro.

PERFORMANCE CURVES - 60 HZ, 3500 RPM CURVAS DE FUNCIONAMIENTO - 60 HZ, 3500 RPM

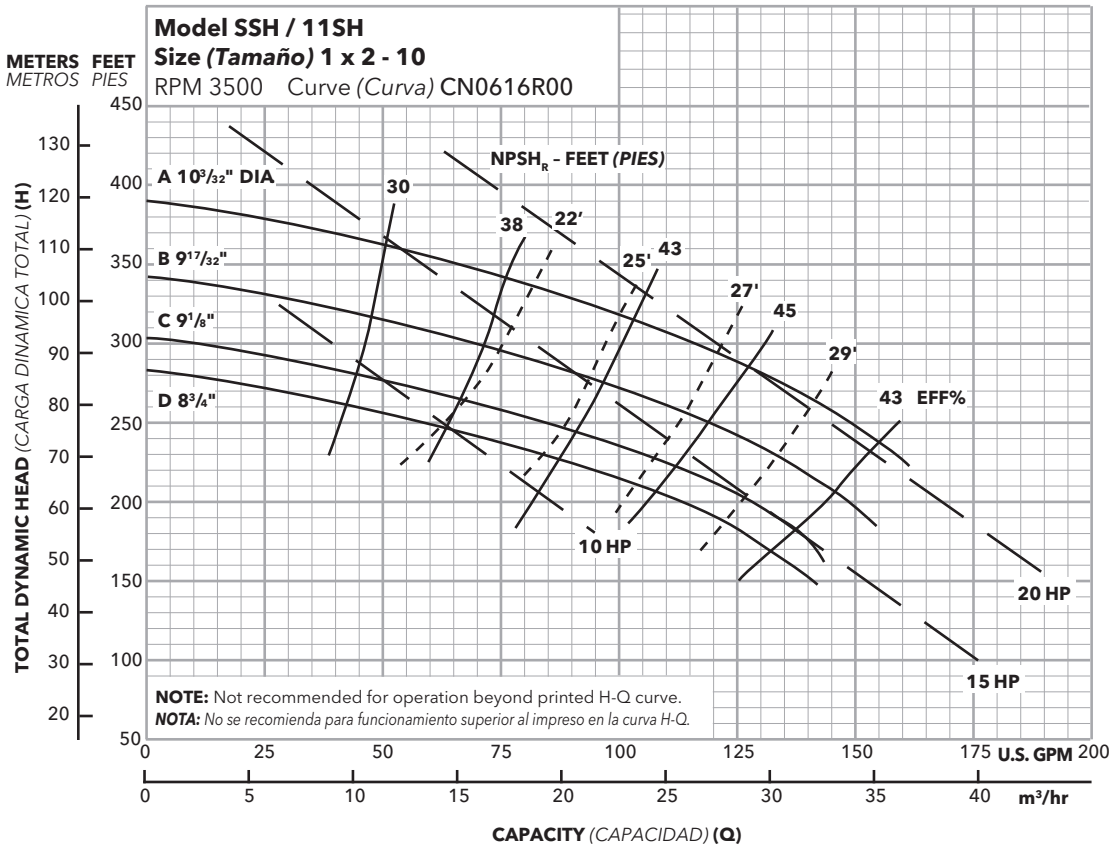

Optional Impeller, Impulsor Opcional		
Impeller Code, Código del Impulsor	Dia., Diá.	Standard HP Rating, Estándar HP Potencia
A	10 ³ / ₃₂ "	20
B	9 ¹⁷ / ₃₂ "	15
C	9 ¹ / ₈ "	15
D	8 ³ / ₄ "	15

NOTE: Pump will pass a sphere to 1/8" diameter.

NOTA: La bomba pasará una esfera a 1/8" diámetro.

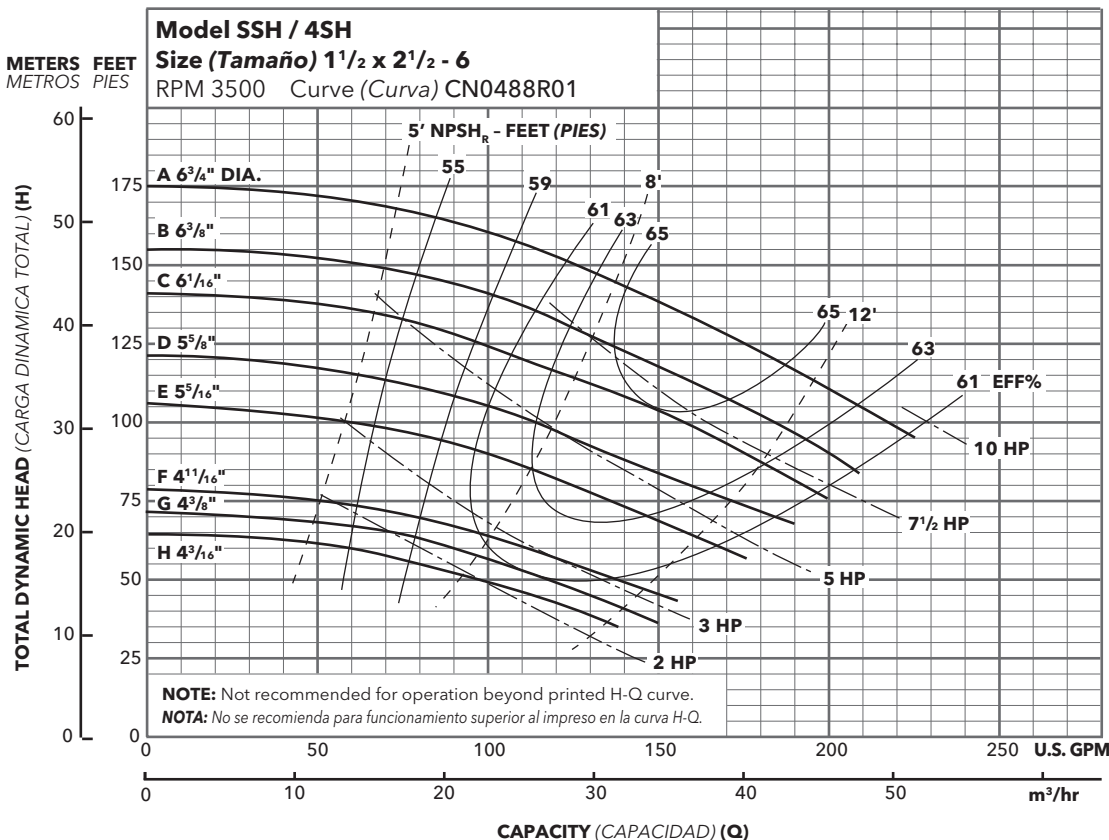

Optional Impeller, Impulsor Opcional		
Impeller Code, Código del Impulsor	Dia., Diá.	Standard HP Rating, Estándar HP Potencia
A	6 ³ / ₄ "	10
B	6 ³ / ₈ "	7 1/2
C	6 ¹ / ₁₆ "	7 1/2
D	5 ⁵ / ₈ "	5
E	5 ¹ / ₁₆ "	5
F	4 ¹¹ / ₁₆ "	3
G	4 ³ / ₈ "	3
H	4 ³ / ₁₆ "	2

NOTE: Pump will pass a sphere to 3/16" diameter.

NOTA: La bomba pasará una esfera a 3/16" diámetro.

PERFORMANCE CURVES - 60 HZ, 3500 RPM CURVAS DE FUNCIONAMIENTO - 60 HZ, 3500 RPM

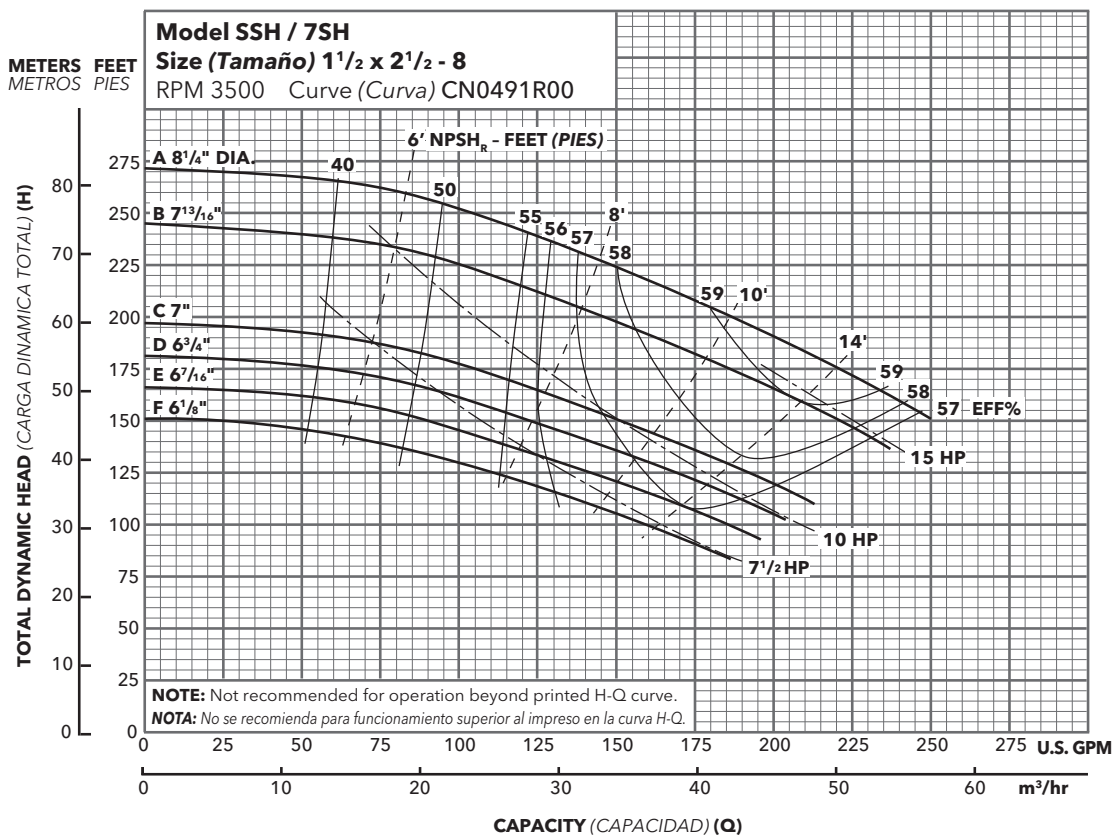

Optional Impeller, Impulsor Opcional		
Impeller Code, Código del Impulsor	Dia., Diá.	Standard HP Rating, Estándar HP Potencia
A	8 1/4"	15
B	7 13/16"	15
C	7	10
D	6 3/4"	10
E	6 7/16"	7 1/2
F	6 1/8"	7 1/2

NOTE: Pump will pass a sphere to 3/16" diameter.

NOTA: La bomba pasará una esfera a 3/16" diámetro.

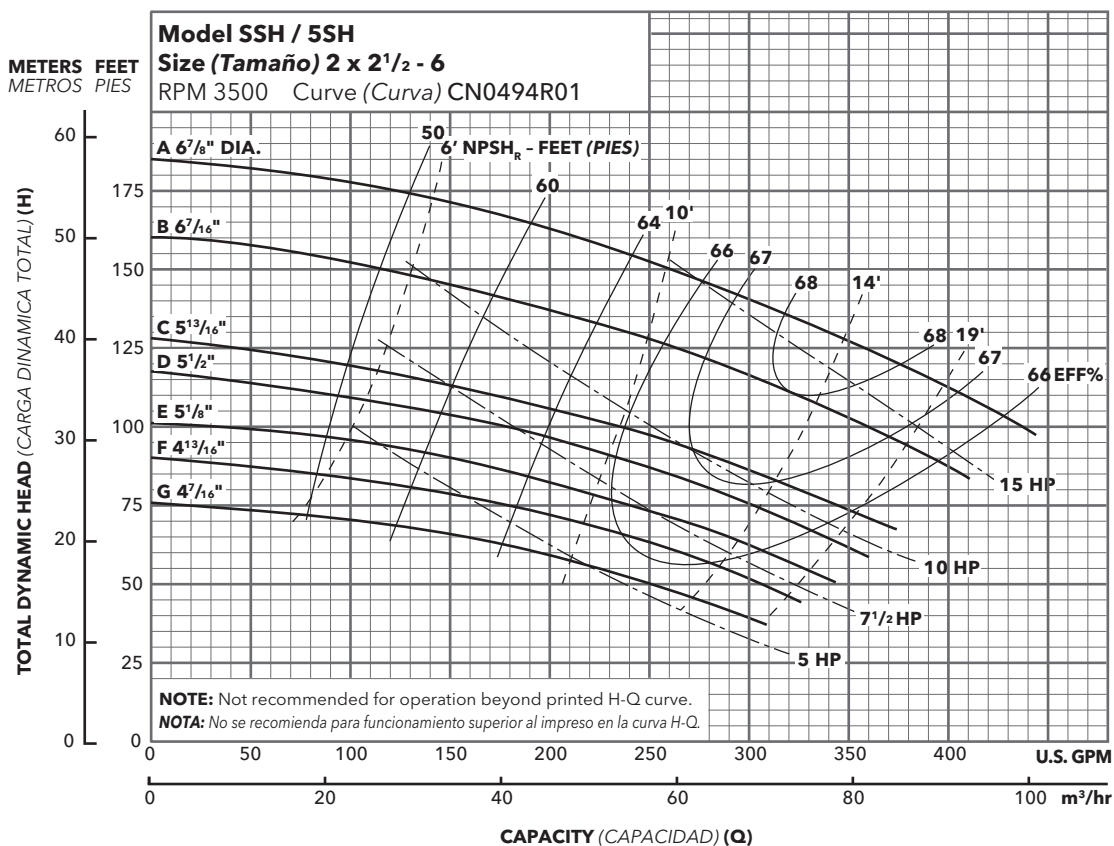

Optional Impeller, Impulsor Opcional		
Impeller Code, Código del Impulsor	Dia., Diá.	Standard HP Rating, Estándar HP Potencia
A	6 7/8"	15
B	6 7/16"	15
C	5 13/16"	10
D	5 1/2"	10
E	5 1/8"	7 1/2
F	4 13/16"	7 1/2
G	4 7/16"	5

NOTE: Pump will pass a sphere to 3/16" diameter.

NOTA: La bomba pasará una esfera a 3/16" diámetro.

PERFORMANCE CURVES - 60 HZ, 3500 RPM CURVAS DE FUNCIONAMIENTO - 60 HZ, 3500 RPM

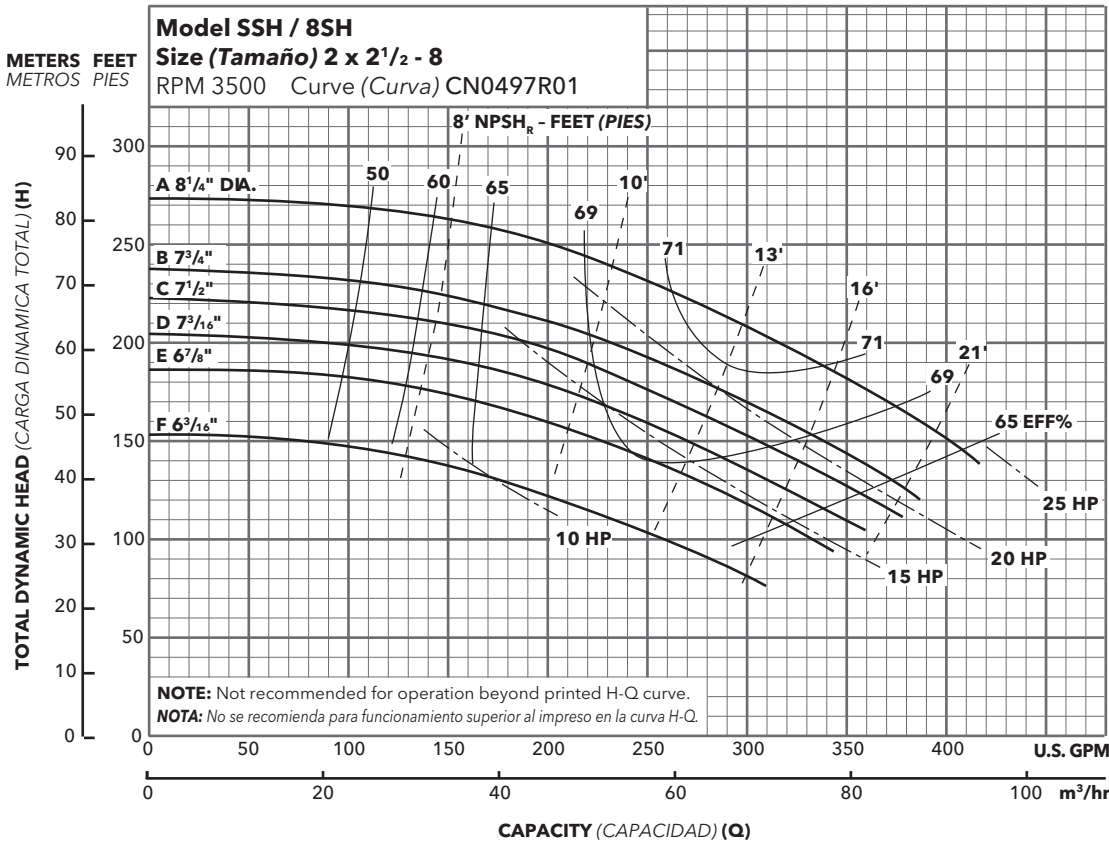

Optional Impeller, Impulsor Opcional		
Impeller Code, Código del Impulsor	Dia., Diá.	Standard HP Rating, Estándar HP Potencia
A	8 1/4"	25
B	7 3/4"	20
C	7 1/2"	20
D	7 3/16"	15
E	6 7/8"	15
F	6 3/16"	10

NOTE: Pump will pass a sphere to 1/4" diameter.

NOTA: La bomba pasará una esfera a 1/4" diámetro.

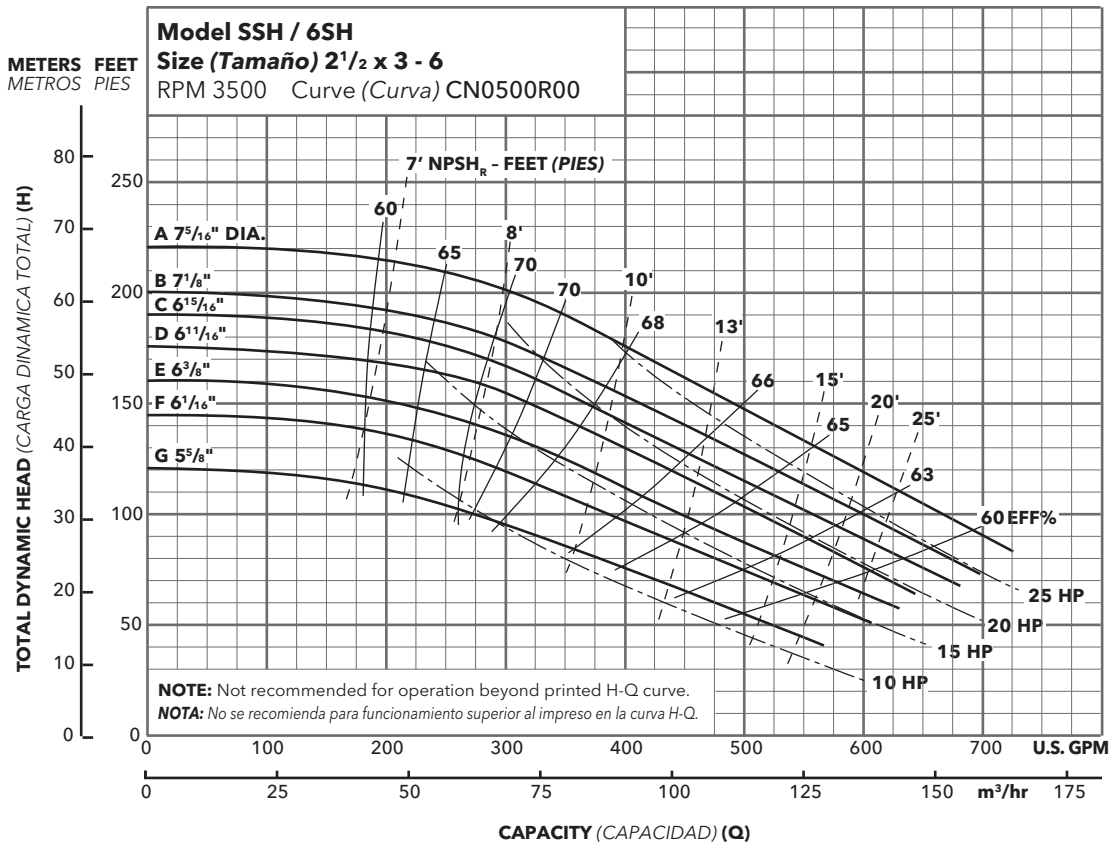

Optional Impeller, Impulsor Opcional		
Impeller Code, Código del Impulsor	Dia., Diá.	Standard HP Rating, Estándar HP Potencia
A	7 5/16"	25
B	7 1/8"	25
C	6 15/16"	20
D	6 1 1/16"	20
E	6 3/8"	15
F	6 1/16"	15
G	5 5/8"	10

NOTE: Pump will pass a sphere to 5/16" diameter.

NOTA: La bomba pasará una esfera a 5/16" diámetro.

PERFORMANCE CURVES - 60 HZ, 1750 RPM CURVAS DE FUNCIONAMIENTO - 60 HZ, 1750 RPM

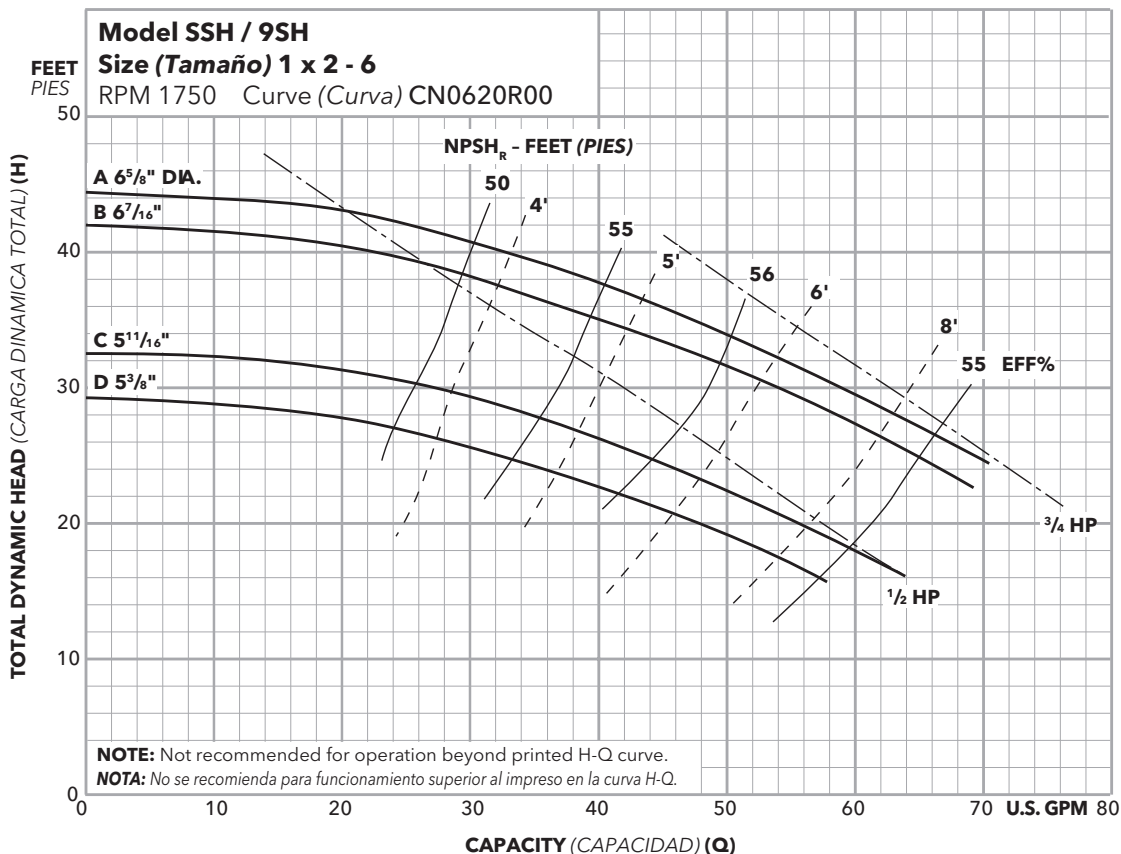

Optional Impeller, Impulsor Opcional		
Impeller Code, Código del Impulsor	Dia., Diá.	Standard HP Rating, Estándar HP Potencia
A	6 ⁵ / ₈ "	3/4
B	6 ⁷ / ₁₆ "	3/4
C	5 ¹ / ₁₆ "	1/2
D	5 ³ / ₈ "	1/2

NOTE: Pump will pass a sphere to 1/8" diameter.

NOTA: La bomba pasará una esfera a 1/8" diámetro.

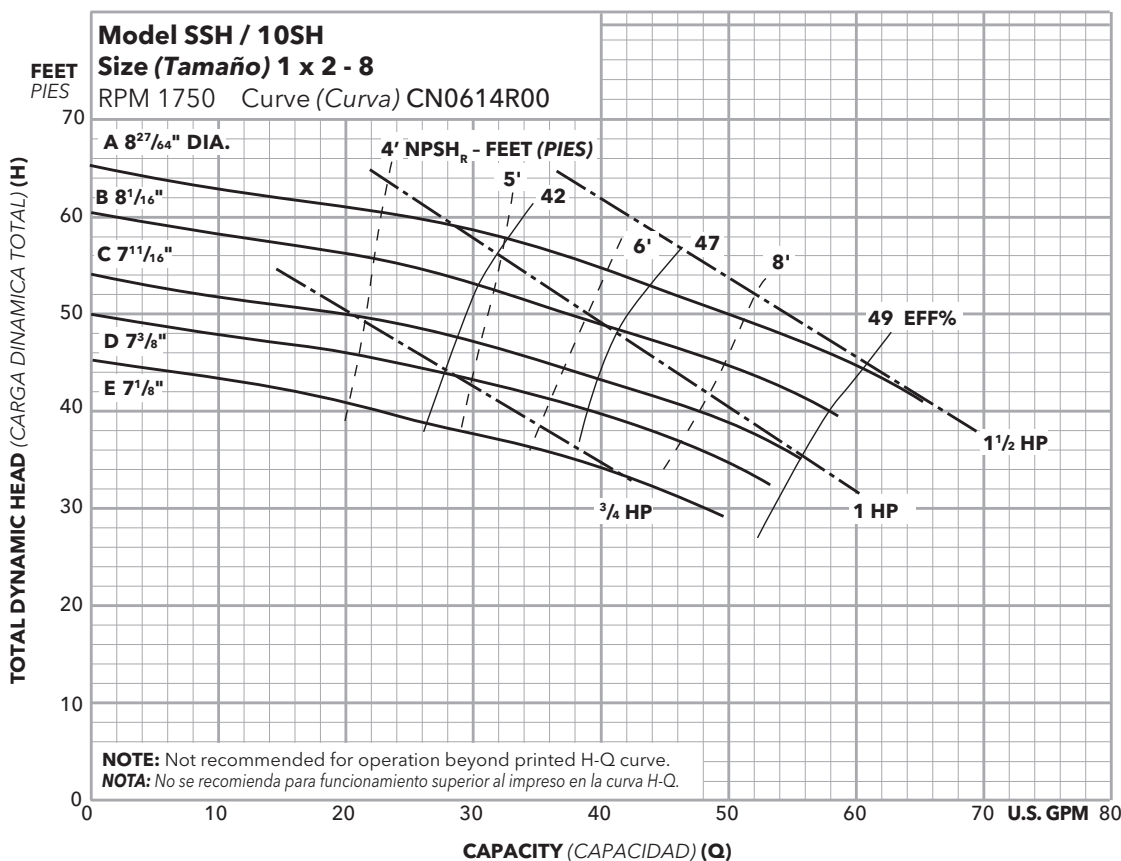

Optional Impeller, Impulsor Opcional		
Impeller Code, Código del Impulsor	Dia., Diá.	Standard HP Rating, Estándar HP Potencia
A	8 ²⁷ / ₆₄ "	1 1/2
B	8 ¹ / ₁₆ "	1 1/2
C	7 ¹ / ₁₆ "	1
D	7 ³ / ₈ "	3/4
E	7 ¹ / ₈ "	3/4

NOTE: Pump will pass a sphere to 1/8" diameter.

NOTA: La bomba pasará una esfera a 1/8" diámetro.

PERFORMANCE CURVES - 60 HZ, 1750 RPM CURVAS DE FUNCIONAMIENTO - 60 HZ, 1750 RPM

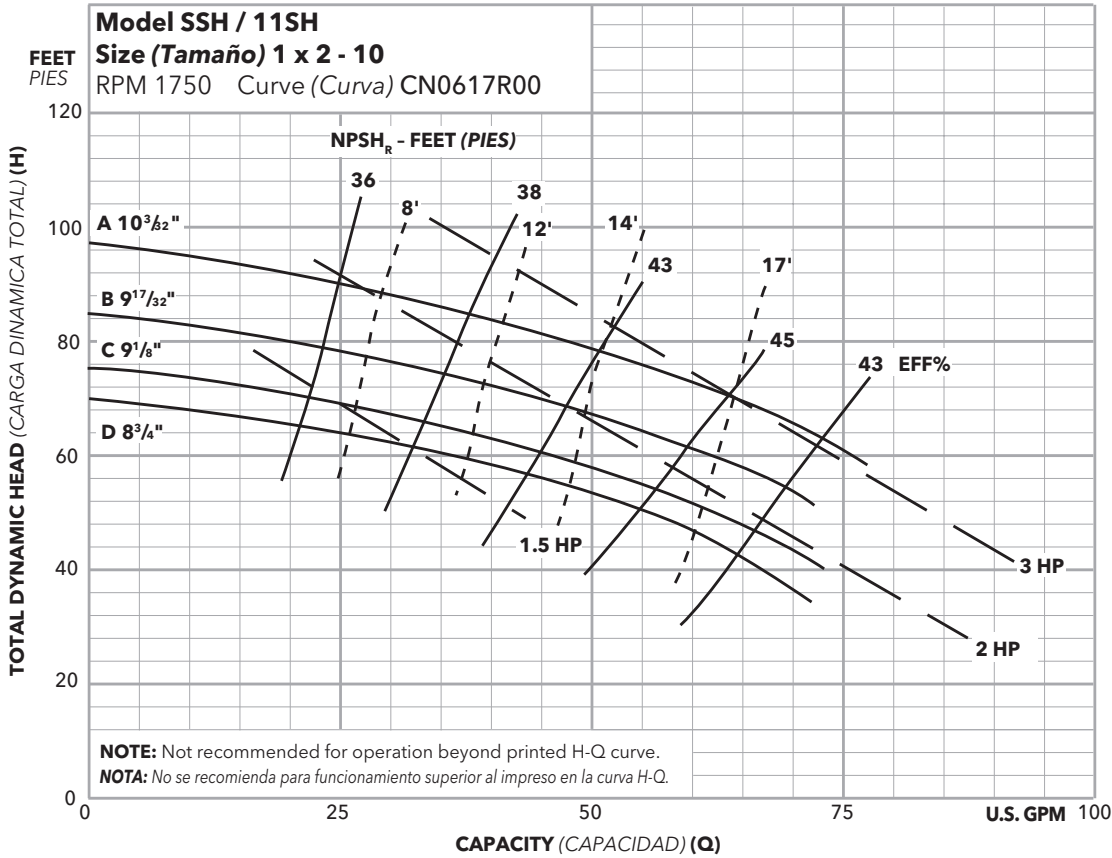

Optional Impeller, Impulsor Opcional		
Impeller Code, Código del Impulsor	Dia., Diá.	Standard HP Rating, Estándar HP Potencia
A	10 ³ / ₃₂ "	3
B	9 ¹⁷ / ₃₂ "	3
C	9 ¹ / ₈ "	2
D	8 ³ / ₄ "	2

NOTE: Pump will pass a sphere to 1/8" diameter.

NOTA: La bomba pasará una esfera a 1/8" diámetro.

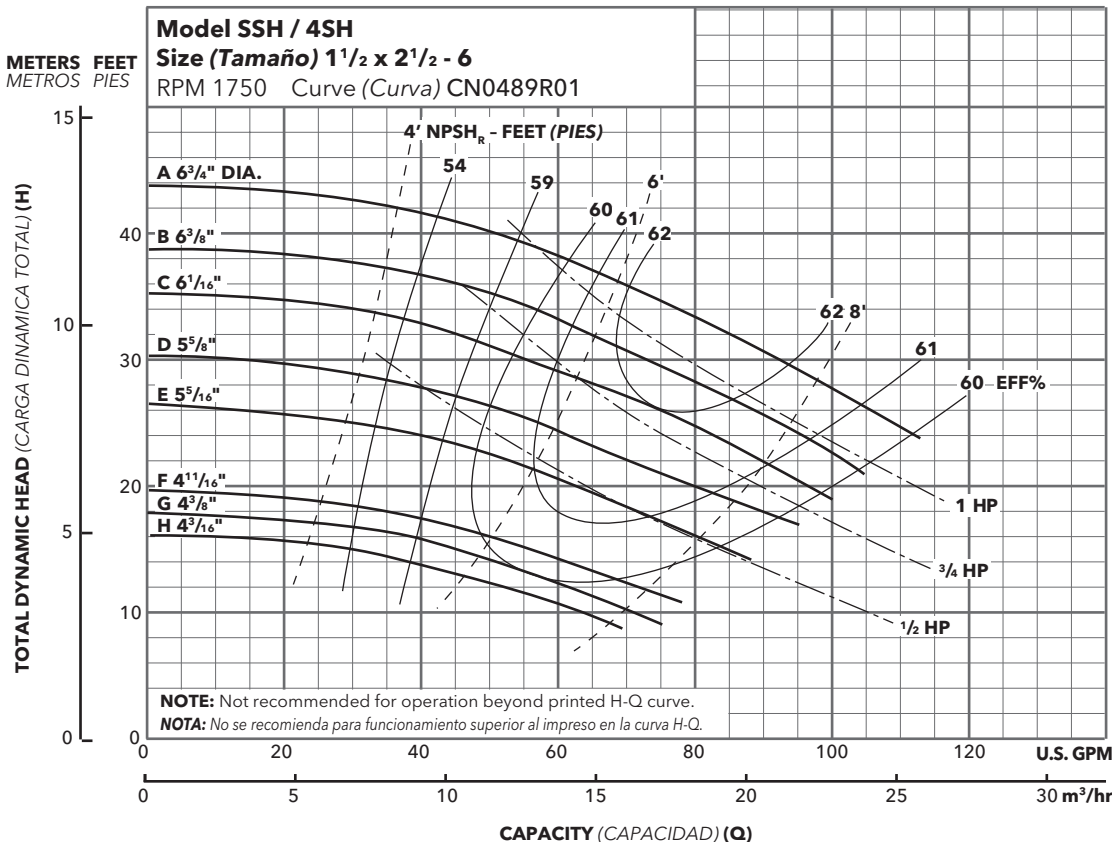

Optional Impeller, Impulsor Opcional		
Impeller Code, Código del Impulsor	Dia., Diá.	Standard HP Rating, Estándar HP Potencia
A	6 ³ / ₄ "	1
B	6 ³ / ₈ "	1
C	6 ¹ / ₁₆ "	1
D	5 ⁵ / ₈ "	3/4
E	5 ⁵ / ₁₆ "	3/4
F	4 ¹¹ / ₁₆ "	1/2
G	4 ³ / ₈ "	1/2
H	4 ³ / ₁₆ "	1/2

NOTE: Pump will pass a sphere to 3/16" diameter.

NOTA: La bomba pasará una esfera a 3/16" diámetro.

Commercial Water

PERFORMANCE CURVES - 60 HZ, 1750 RPM CURVAS DE FUNCIONAMIENTO - 60 HZ, 1750 RPM

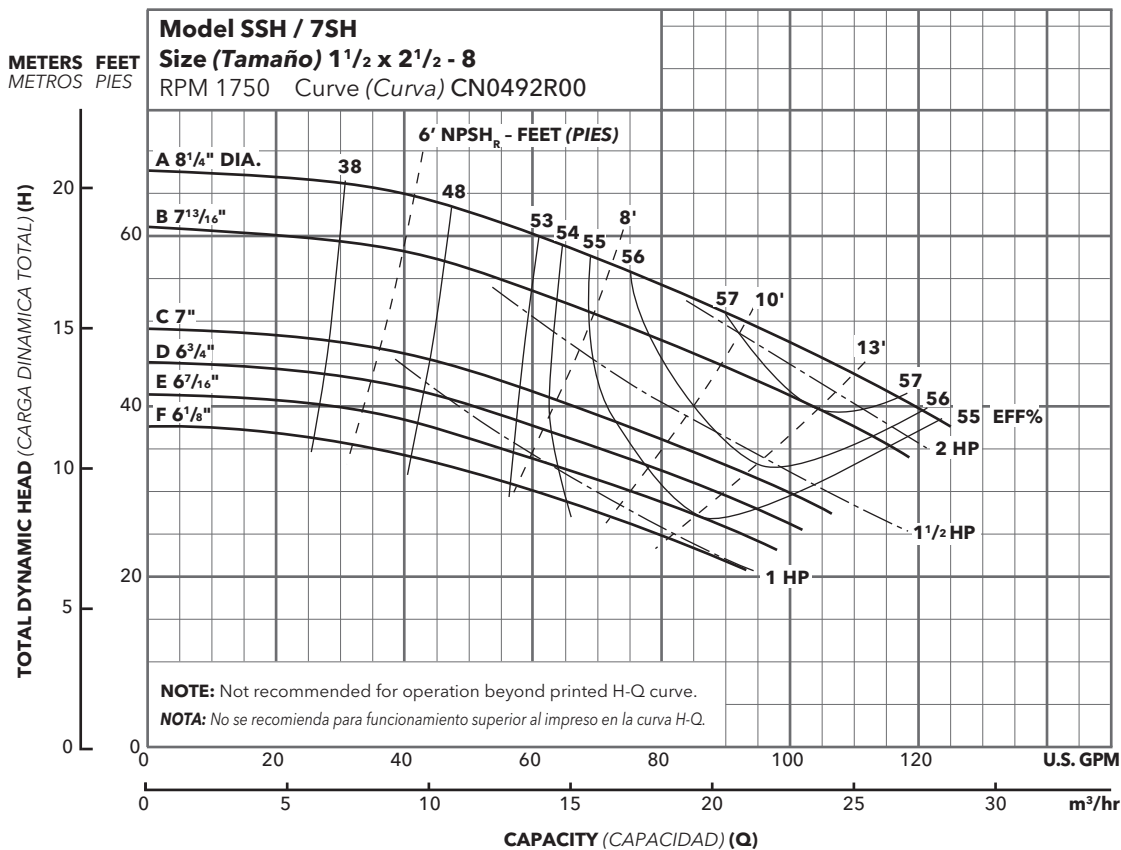

Optional Impeller, Impulsor Opcional		
Impeller Code, Código del Impulsor	Dia., Diá.	Standard HP Rating, Estándar HP Potencia
A	8 1/4"	2
B	7 13/16"	2
C	7	1 1/2
D	6 3/4"	1 1/2
E	6 7/16"	1
F	6 1/8"	1

NOTE: Pump will pass a sphere to 3/16" diameter.
 NOTA: La bomba pasará una esfera a 3/16" diámetro.

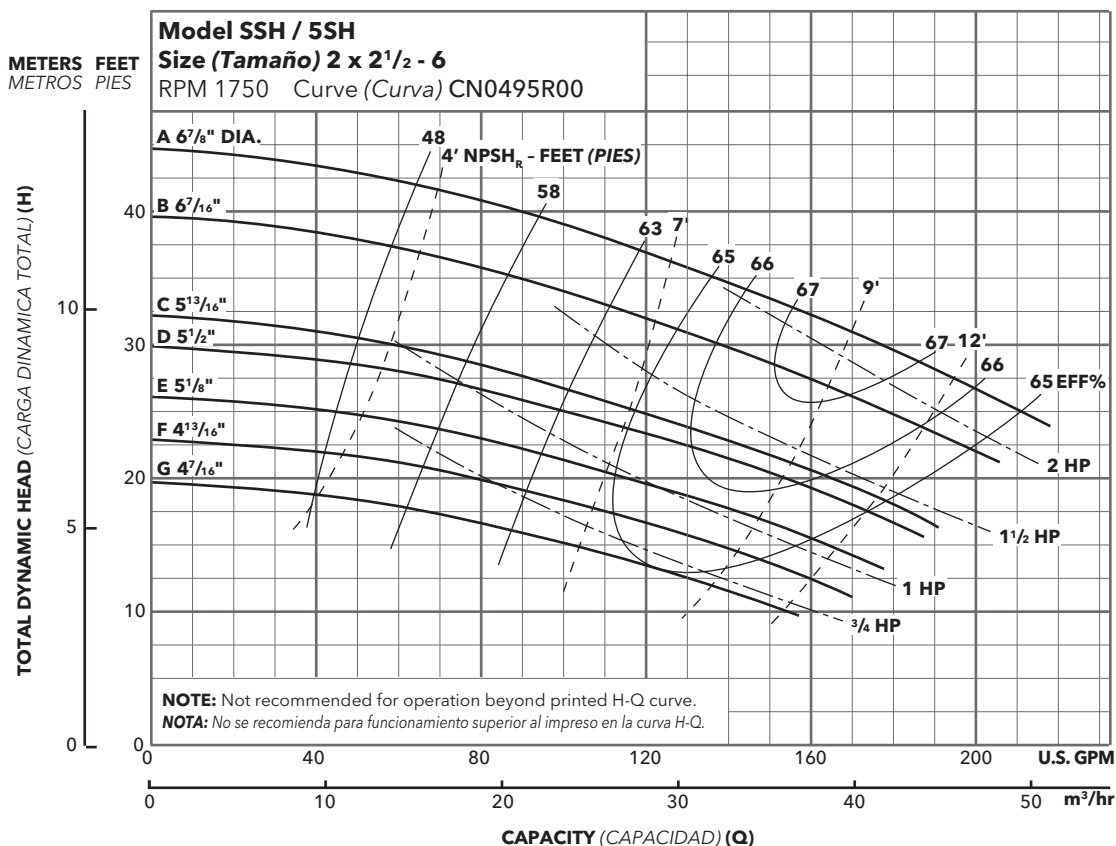

Optional Impeller, Impulsor Opcional		
Impeller Code, Código del Impulsor	Dia., Diá.	Standard HP Rating, Estándar HP Potencia
A	6 7/8"	2
B	6 7/16"	2
C	5 13/16"	1 1/2
D	5 1/2"	1 1/2
E	5 1/8"	1
F	4 13/16"	1
G	4 7/16"	3/4

NOTE: Pump will pass a sphere to 5/32" diameter.
 NOTA: La bomba pasará una esfera a 5/32" diámetro.

PERFORMANCE CURVES - 60 HZ, 1750 RPM CURVAS DE FUNCIONAMIENTO - 60 HZ, 1750 RPM

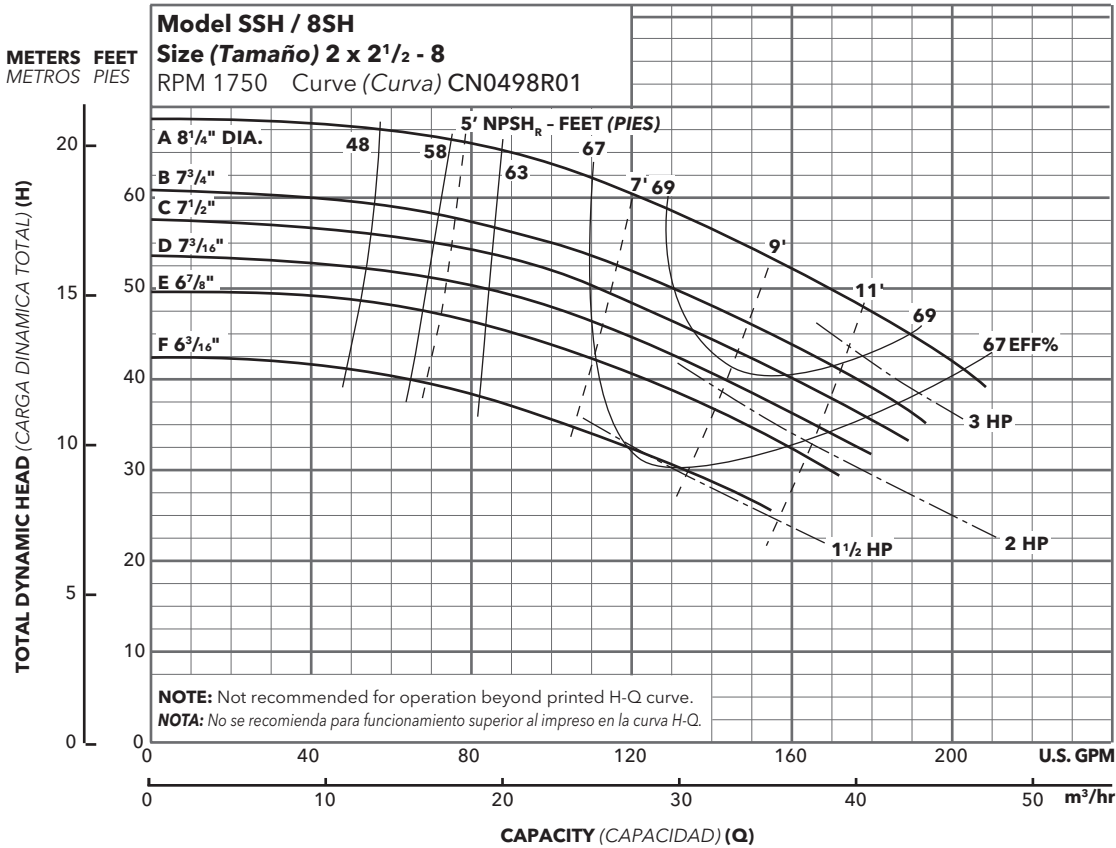

Optional Impeller, Impulsor Opcional

Impeller Code, Código del Impulsor	Dia., Diá.	Standard HP Rating, Estándar HP Potencia
A	8 1/4"	3
B	7 3/4"	3
C	7 1/2"	2
D	7 3/16"	2
E	6 7/8"	1 1/2
F	6 3/16"	1 1/2

NOTE: Pump will pass a sphere to 5/32" diameter.
NOTA: La bomba pasará una esfera a 5/32" diámetro.

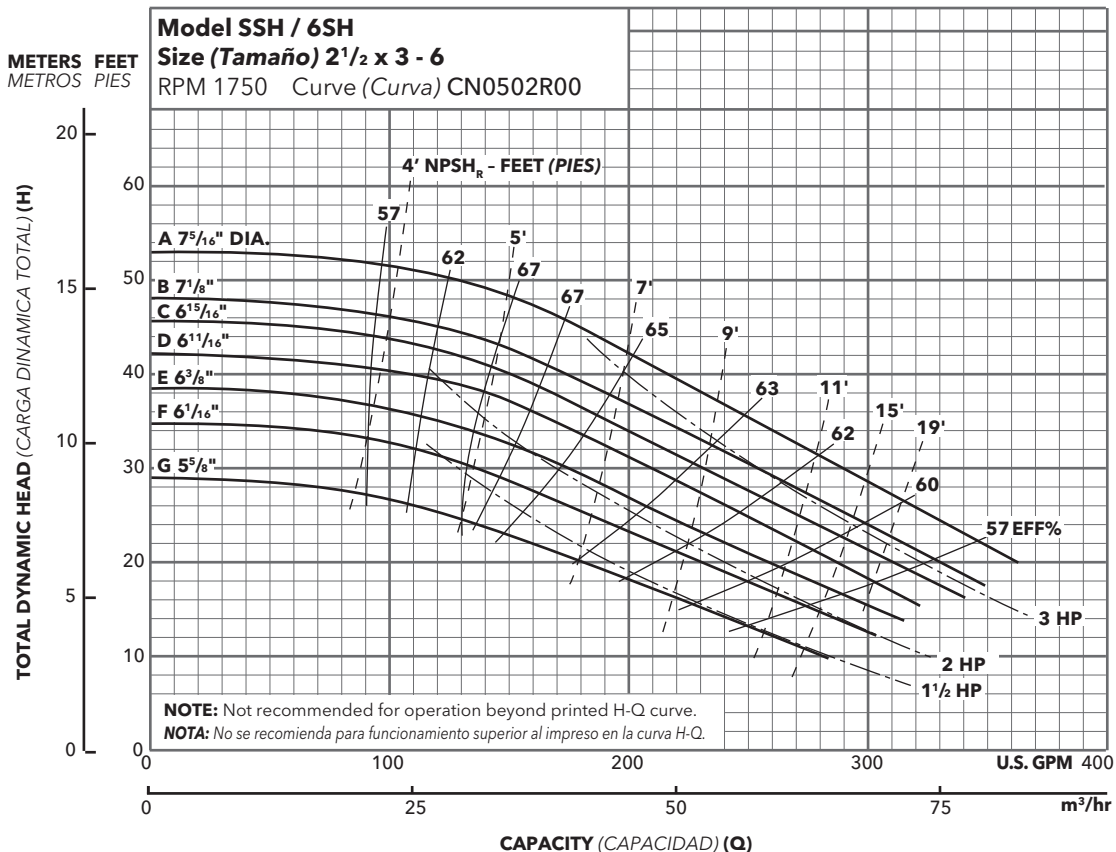

Optional Impeller, Impulsor Opcional

Impeller Code, Código del Impulsor	Dia., Diá.	Standard HP Rating, Estándar HP Potencia
A	7 5/16"	3
B	7 1/8"	3
C	6 15/16"	3
D	6 1 1/16"	3
E	6 3/8"	2
F	6 1/16"	2
G	5 5/8"	1 1/2

NOTE: Pump will pass a sphere to 1/16" diameter.
NOTA: La bomba pasará una esfera a 1/16" diámetro.

PERFORMANCE CURVES - 50 HZ, 2900 RPM CURVAS DE FUNCIONAMIENTO - 50 HZ, 2900 RPM

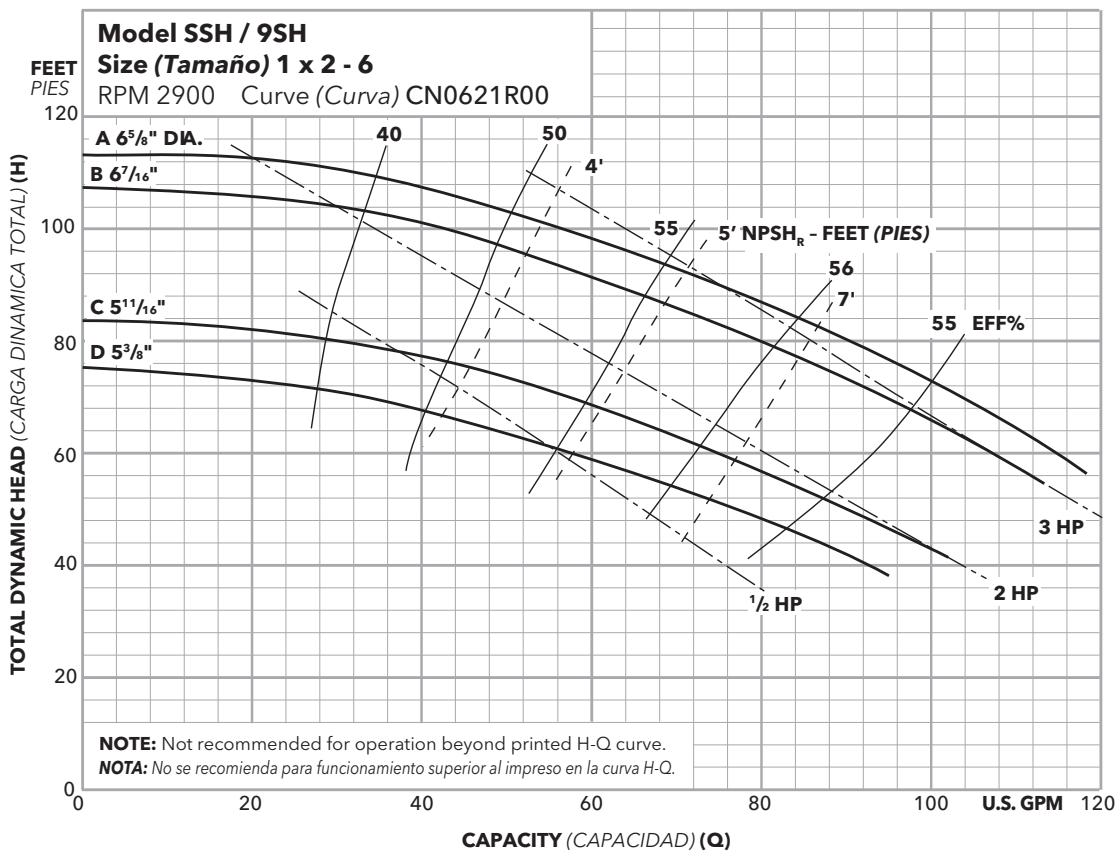

Optional Impeller, Impulsor Opcional		
Impeller Code, Código del Impulsor	Dia., Diá.	Standard HP Rating, Estándar HP Potencia
A	6 ⁵ / ₈ "	3
B	6 ⁷ / ₁₆ "	3
C	5 ¹ / ₁₆ "	2
D	5 ³ / ₈ "	2

NOTE: Pump will pass a sphere to 1/8" diameter.

NOTA: La bomba pasará una esfera a 1/8" diámetro.

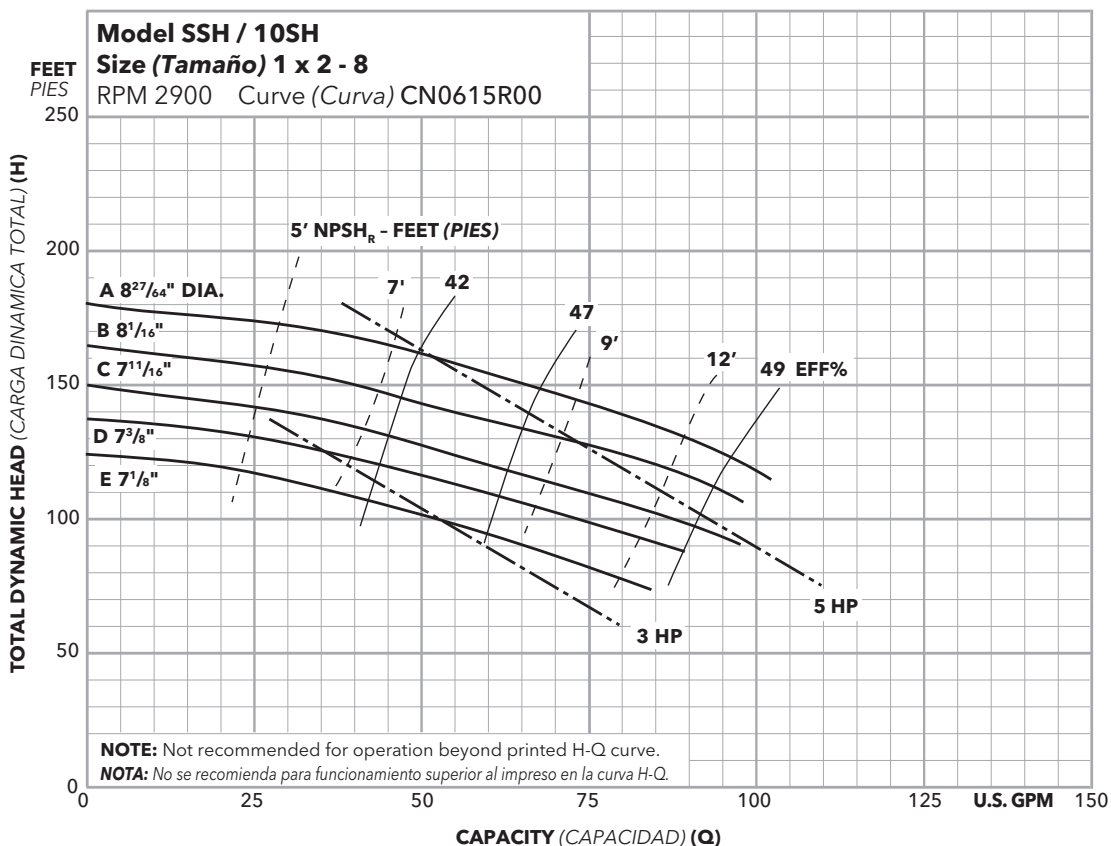

Optional Impeller, Impulsor Opcional		
Impeller Code, Código del Impulsor	Dia., Diá.	Standard HP Rating, Estándar HP Potencia
A	8 ²⁷ / ₆₄ "	5
B	8 ¹ / ₁₆ "	5
C	7 ¹ / ₁₆ "	5
D	7 ³ / ₈ "	5
E	7 ¹ / ₈ "	3

NOTE: Pump will pass a sphere to 1/8" diameter.

NOTA: La bomba pasará una esfera a 1/8" diámetro.

PERFORMANCE CURVES - 50 HZ, 2900 RPM CURVAS DE FUNCIONAMIENTO - 50 HZ, 2900 RPM

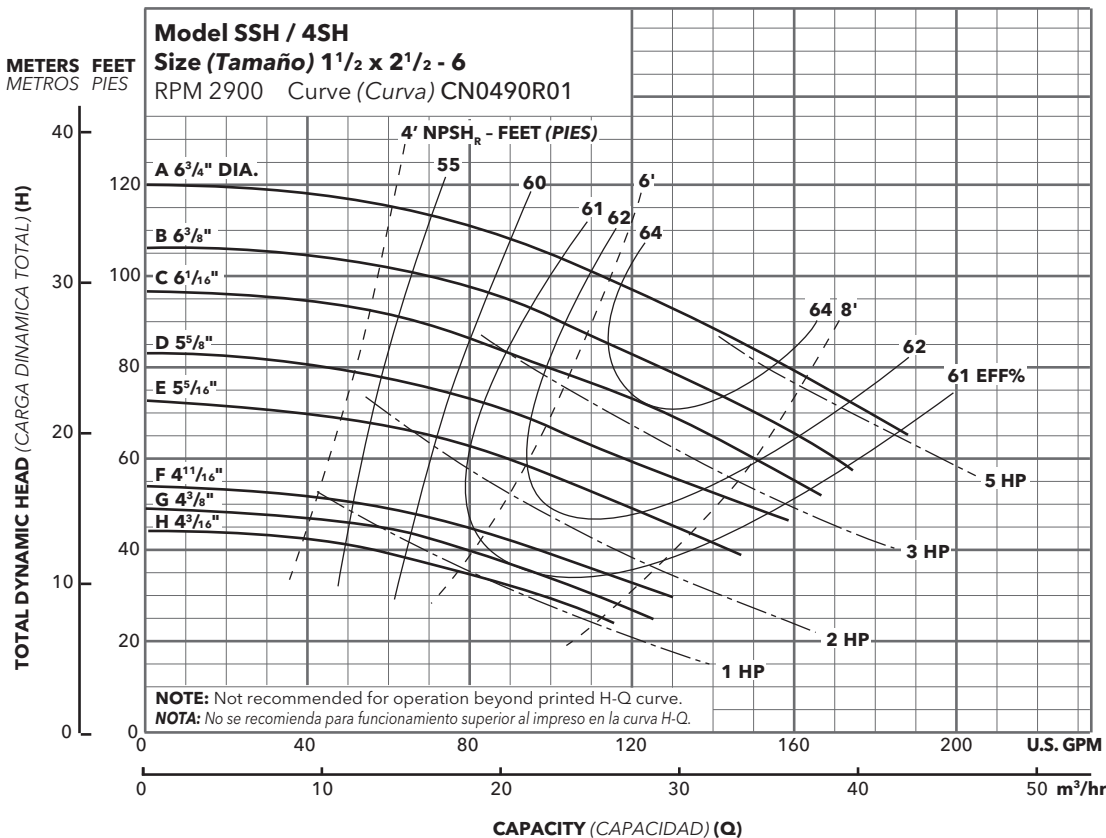
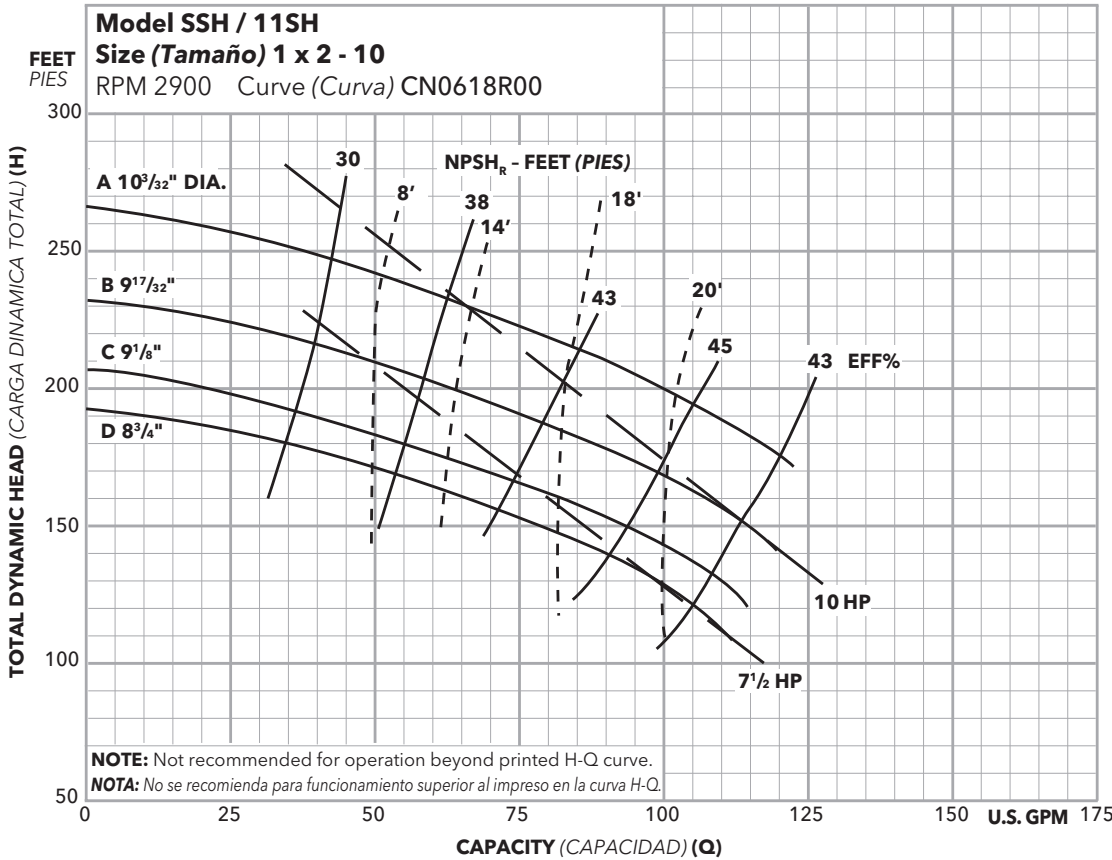

Commercial Water

PERFORMANCE CURVES - 50 HZ, 2900 RPM CURVAS DE FUNCIONAMIENTO - 50 HZ, 2900 RPM

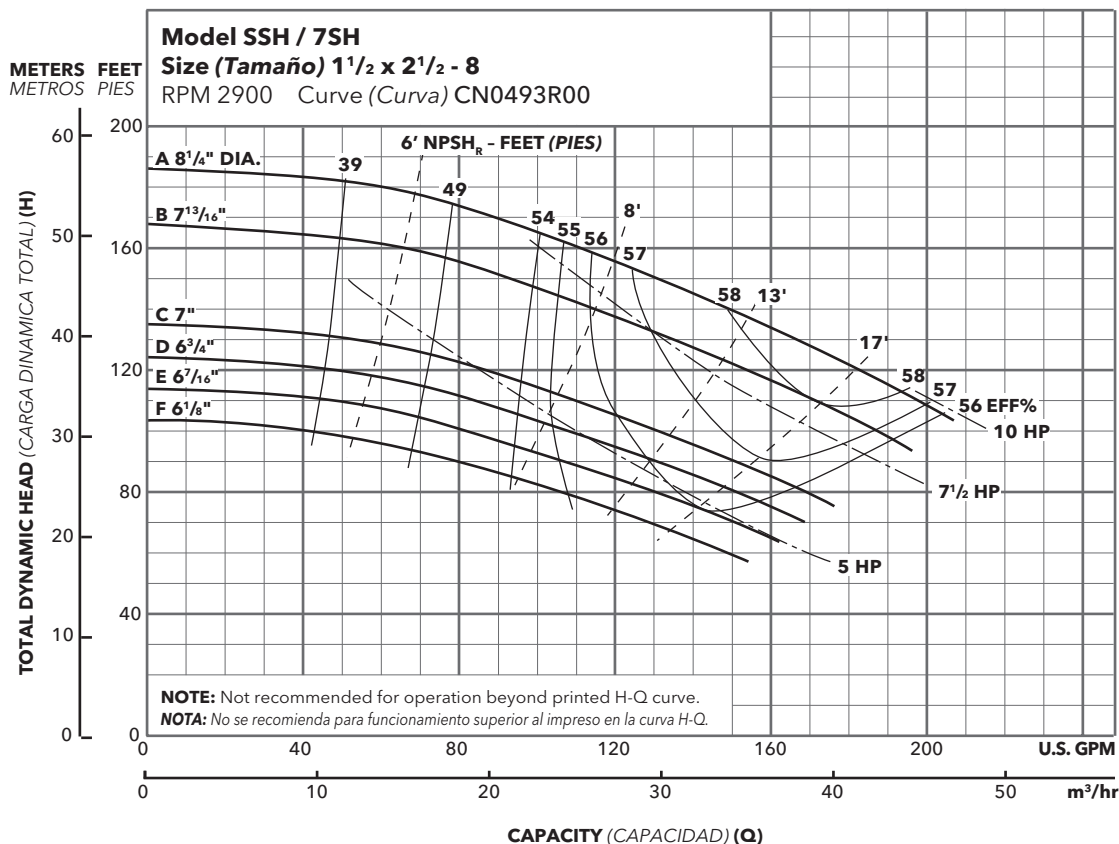

Optional Impeller, Impulsor Opcional

Impeller Code, Código del Impulsor	Dia., Diá.	Standard HP Rating, Estándar HP Potencia
A	8 1/4"	10
B	7 13/16"	7 1/2
C	7"	7 1/2
D	6 3/4"	7 1/2
E	6 7/16"	5
F	6 1/8"	5

NOTE: Pump will pass a sphere to 3/16" diameter.
NOTA: La bomba pasará una esfera a 3/16" diámetro.

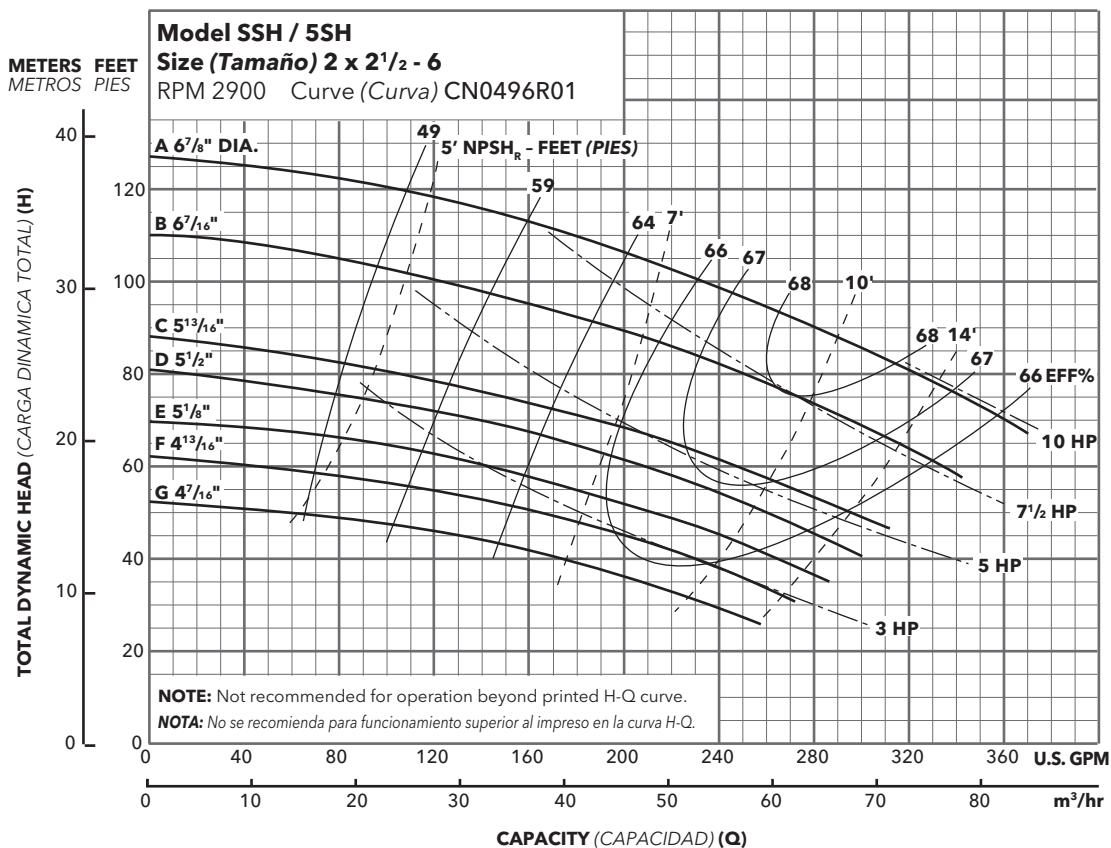

Optional Impeller, Impulsor Opcional

Impeller Code, Código del Impulsor	Dia., Diá.	Standard HP Rating, Estándar HP Potencia
A	6 7/8"	10
B	6 7/16"	7 1/2
C	5 13/16"	7 1/2
D	5 1/2"	5
E	5 1/8"	5
F	4 13/16"	3
G	4 7/16"	3

NOTE: Pump will pass a sphere to 5/32" diameter.
NOTA: La bomba pasará una esfera a 5/32" diámetro.

PERFORMANCE CURVES - 50 HZ, 2900 RPM CURVAS DE FUNCIONAMIENTO - 50 HZ, 2900 RPM

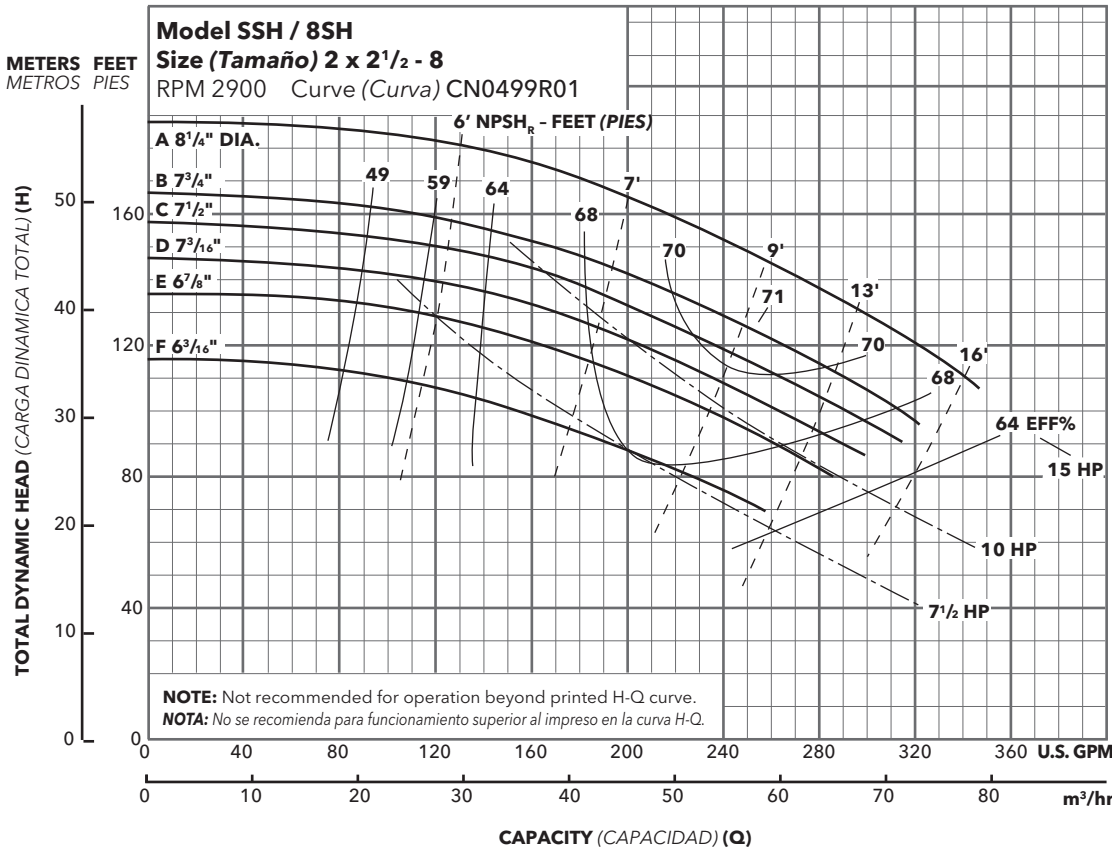

Optional Impeller, Impulsor Opcional

Impeller Code, Código del Impulsor	Dia., Diá.	Standard HP Rating, Estándar HP Potencia
A	8 1/4"	15
B	7 3/4"	15
C	7 1/2"	10
D	7 3/16"	10
E	6 7/8"	7 1/2
F	6 3/16"	7 1/2

NOTE: Pump will pass a sphere to 5/32" diameter.
NOTA: La bomba pasará una esfera a 5/32" diámetro.

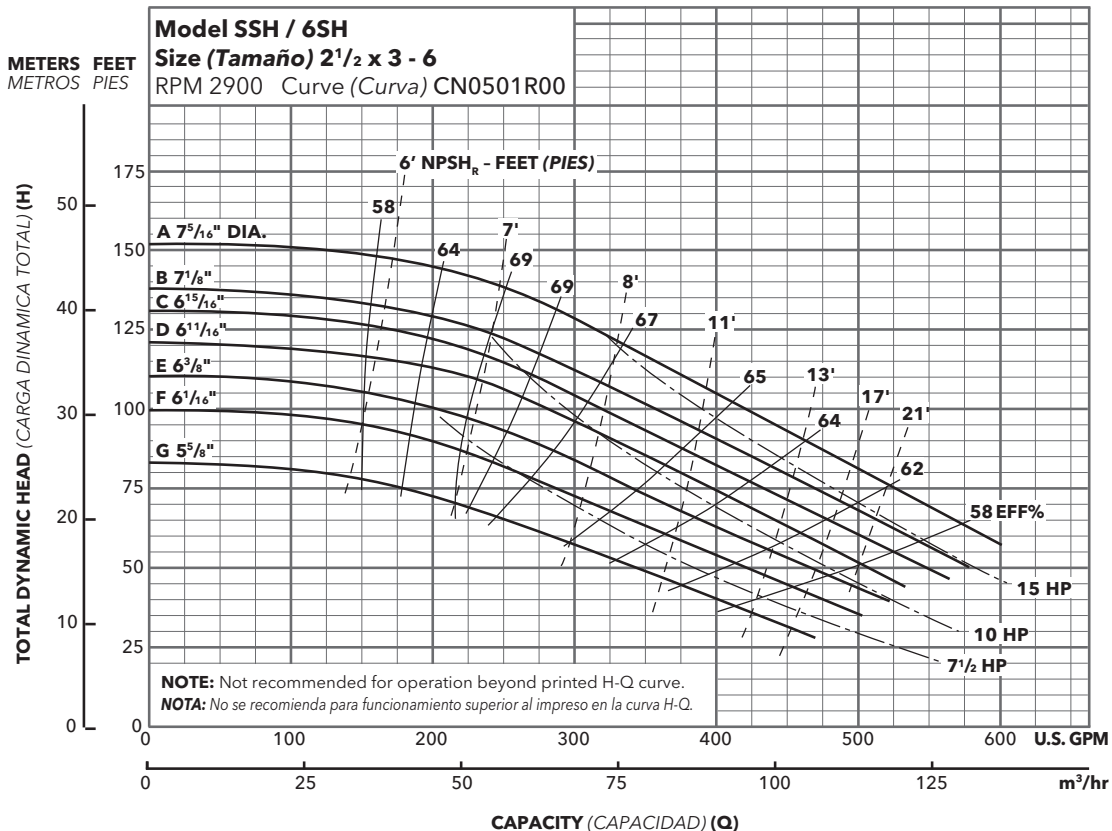

Optional Impeller, Impulsor Opcional

Impeller Code, Código del Impulsor	Dia., Diá.	Standard HP Rating, Estándar HP Potencia
A	7 5/16"	15
B	7 1/8"	15
C	6 15/16"	15
D	6 1 1/16"	10
E	6 3/8"	10
F	6 1/16"	7 1/2
G	5 5/8"	7 1/2

NOTE: Pump will pass a sphere to 1/16" diameter.
NOTA: La bomba pasará una esfera a 1/16" diámetro.

PERFORMANCE CURVES - 60 HZ, 3500 RPM CURVAS DE FUNCIONAMIENTO - 60 HZ, 3500 RPM

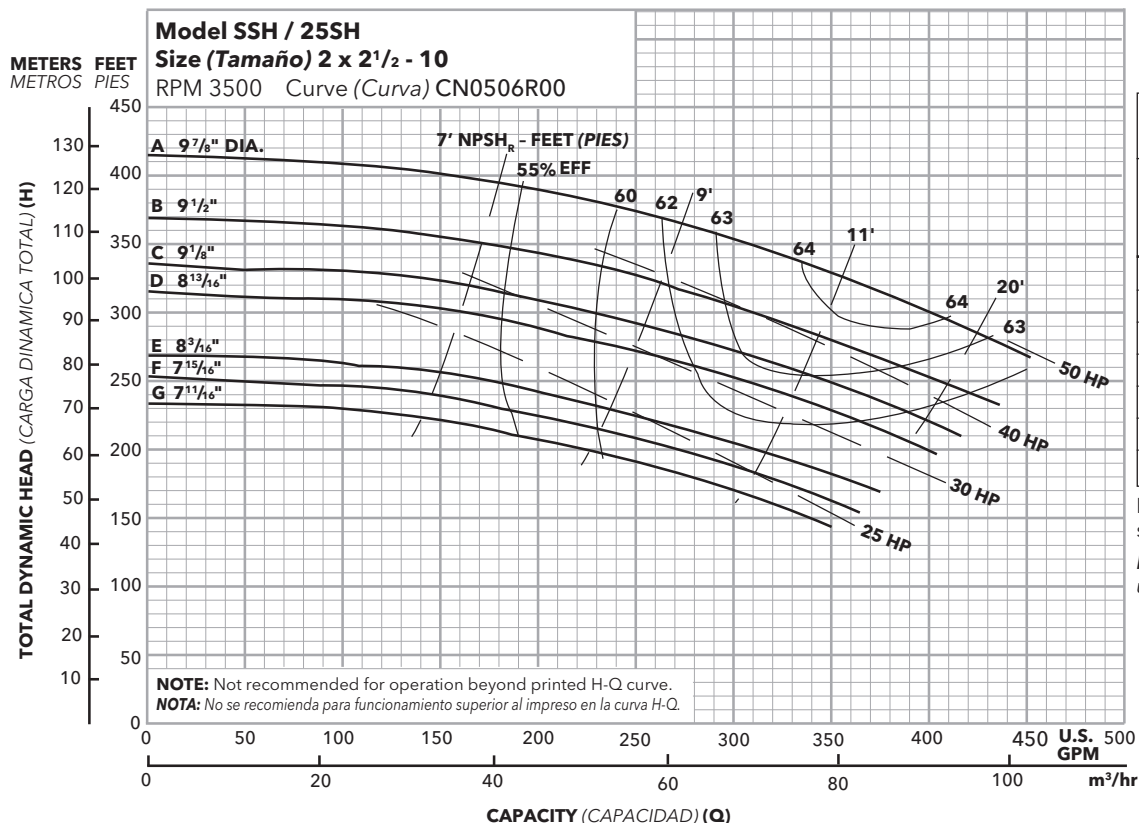
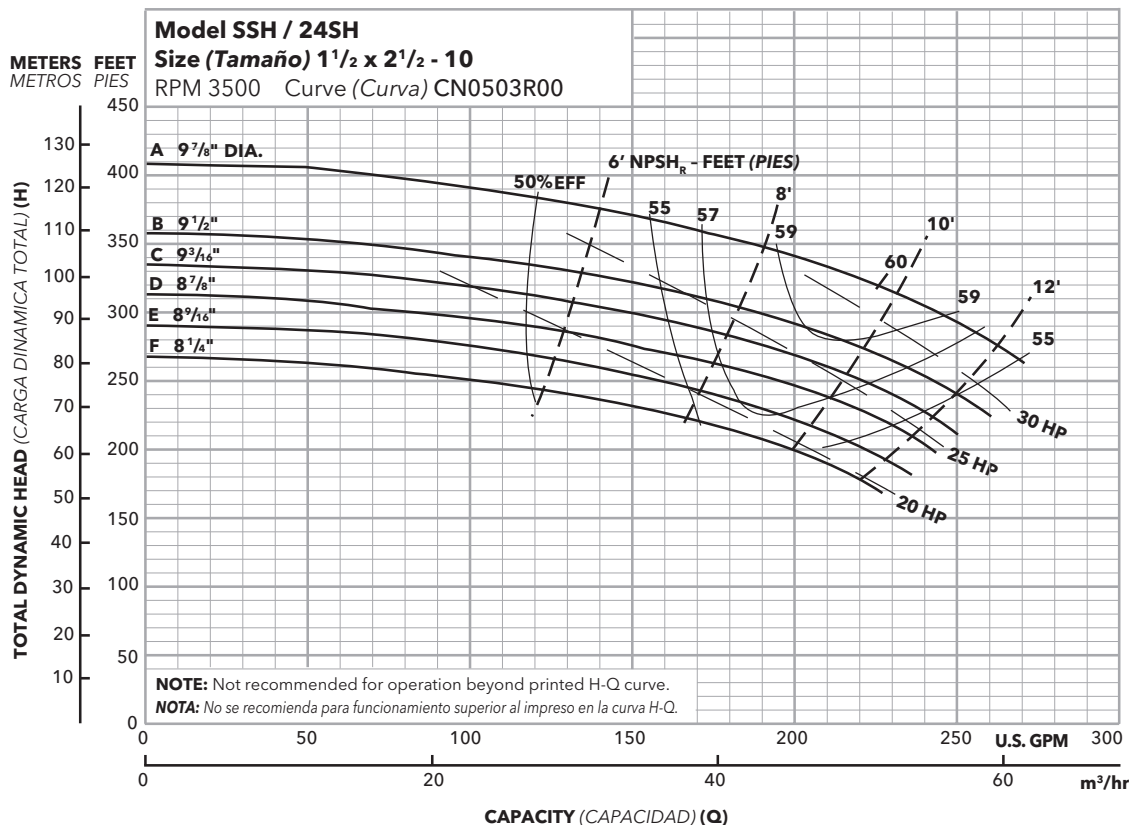

PERFORMANCE CURVES - 60 HZ, 3500 RPM CURVAS DE FUNCIONAMIENTO - 60 HZ, 3500 RPM

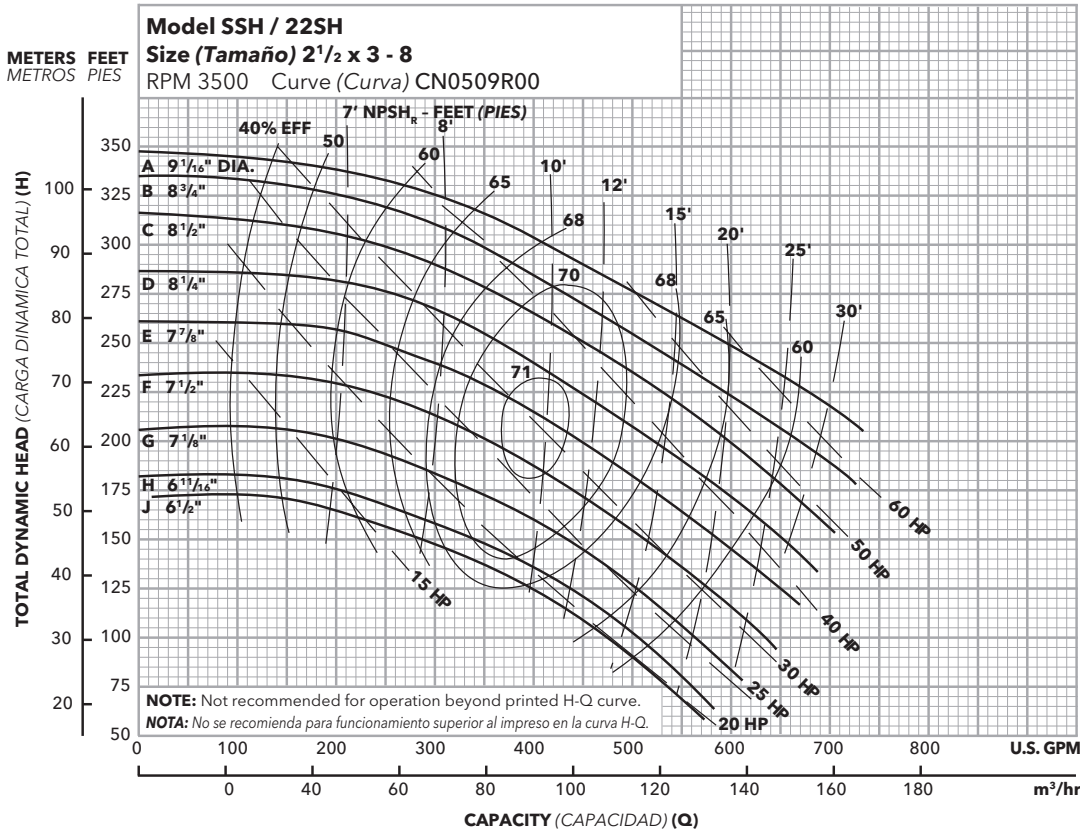

Optional Impeller, Impulsor Opcional		
Impeller Code, Código del Impulsor	Dia., Diá.	Standard HP Rating, Estándar HP Potencia
A	9 1/16"	60
B	8 3/4"	50
C	8 1/2"	50
D	8 1/4"	40
E	7 7/8"	40
F	7 1/2"	30
G	7 1/8"	25
H	6 11/16"	20
J	6 1/2"	20

NOTE: Pump will pass a sphere to 1 1/32" diameter.

NOTA: La bomba pasará una esfera a 1 1/32" diámetro.

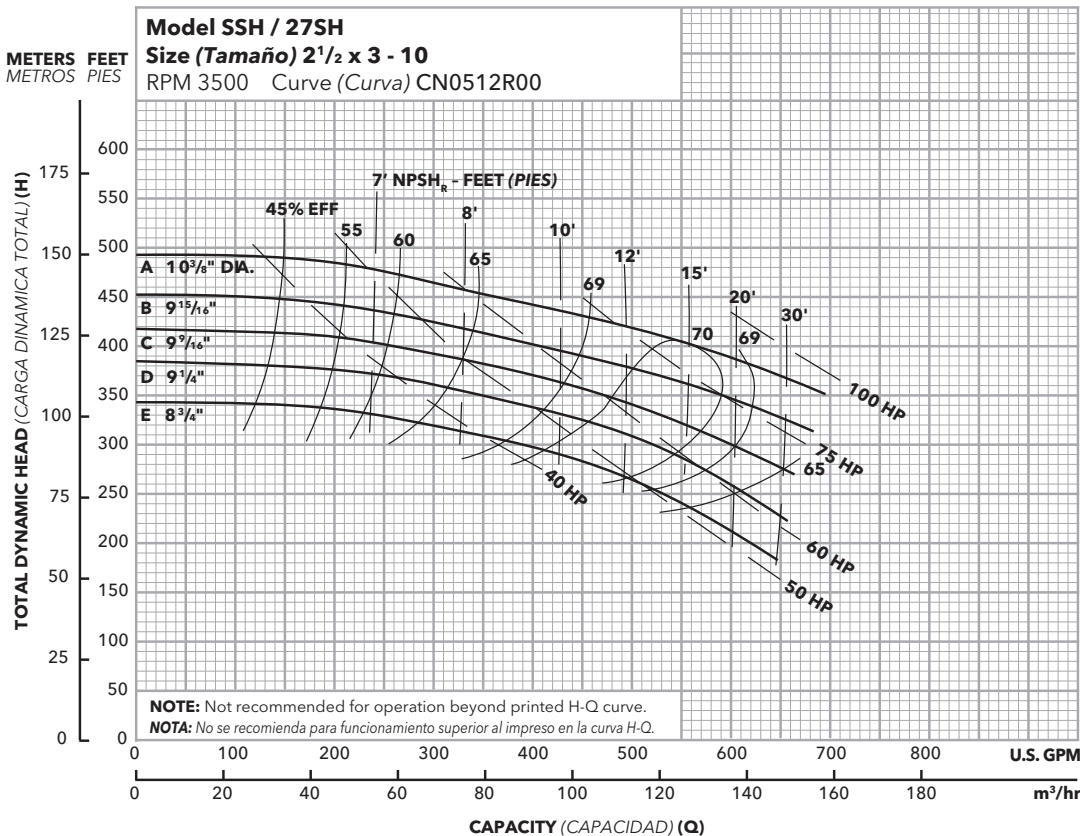

Optional Impeller, Impulsor Opcional		
Impeller Code, Código del Impulsor	Dia., Diá.	Standard HP Rating, Estándar HP Potencia
A	10 3/8"	100
B	9 15/16"	75
C	9 7/16"	75
D	9 1/4"	60
E	8 3/4"	50

NOTE: Pump will pass a sphere to 1 1/32" diameter.

NOTA: La bomba pasará una esfera a 1 1/32" diámetro.

Commercial Water

PERFORMANCE CURVES - 60 HZ, 3500 RPM CURVAS DE FUNCIONAMIENTO - 60 HZ, 3500 RPM

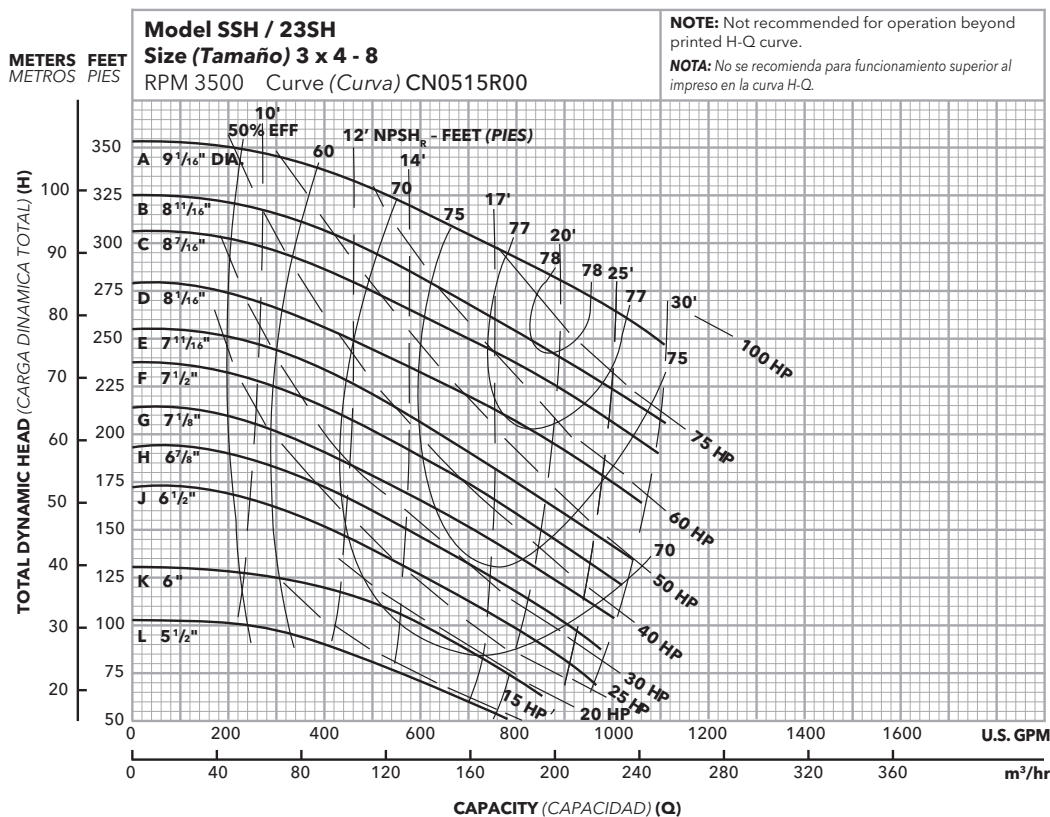

Optional Impeller, Impulsor Opcional		
Impeller Code, Código del Impulsor	Dia., Diá.	Standard HP Rating, Estándar HP Potencia
A	9 ¹ / ₁₆ "	75
B	8 ¹ / ₁₆ "	75
C	8 ⁷ / ₁₆ "	60
D	8 ¹ / ₁₆ "	50
E	7 ¹ / ₁₆ "	50
F	7 ¹ / ₂ "	40
G	7 ¹ / ₈ "	40
H	6 ⁷ / ₈ "	30
J	6 ¹ / ₂ "	25
K	6"	20
L	5 ¹ / ₂ "	15

NOTE: Pump will pass a sphere to 3/4" diameter.

NOTA: La bomba pasará una esfera a 3/4" diámetro.

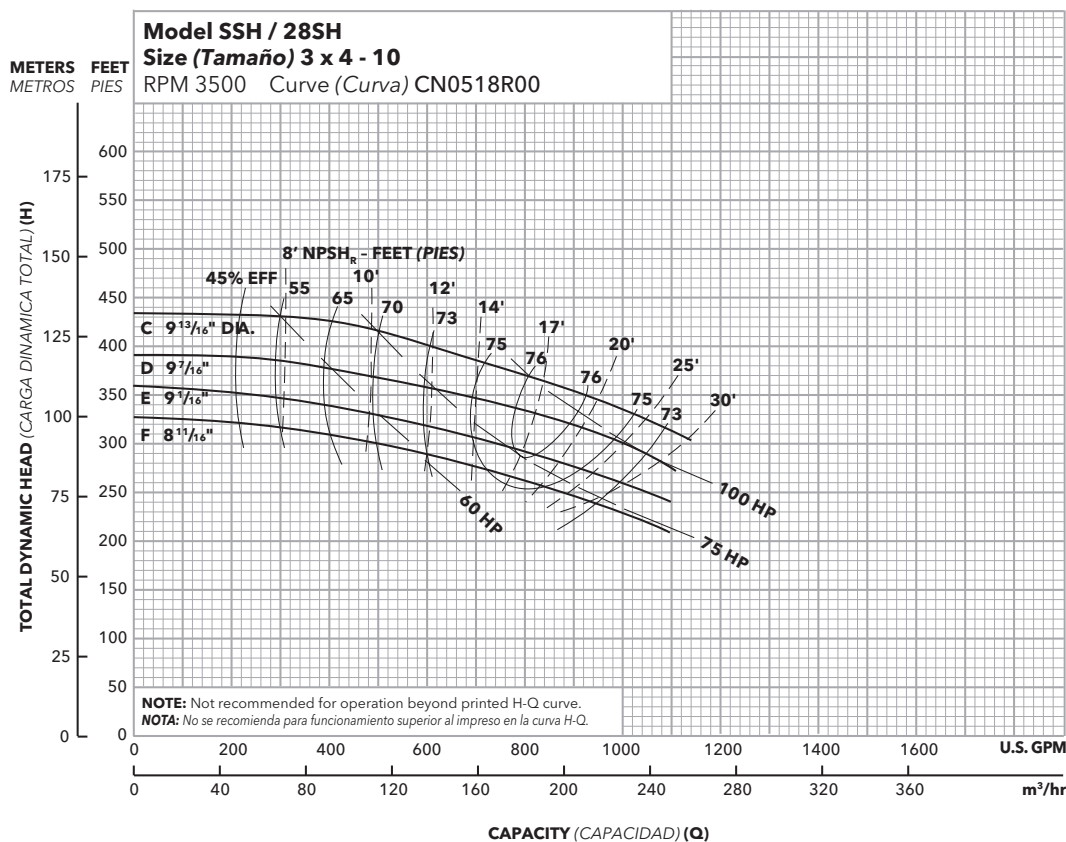

Optional Impeller, Impulsor Opcional		
Impeller Code, Código del Impulsor	Dia., Diá.	Standard HP Rating, Estándar HP Potencia
C	9 ¹³ / ₁₆ "	100
D	9 ⁷ / ₁₆ "	100
E	9 ¹ / ₁₆ "	75
F	8 ¹ / ₁₆ "	75

NOTE: Pump will pass a sphere to 3/4" diameter.

NOTA: La bomba pasará una esfera a 3/4" diámetro.

PERFORMANCE CURVES - 60 HZ, 1750 RPM CURVAS DE FUNCIONAMIENTO - 60 HZ, 1750 RPM

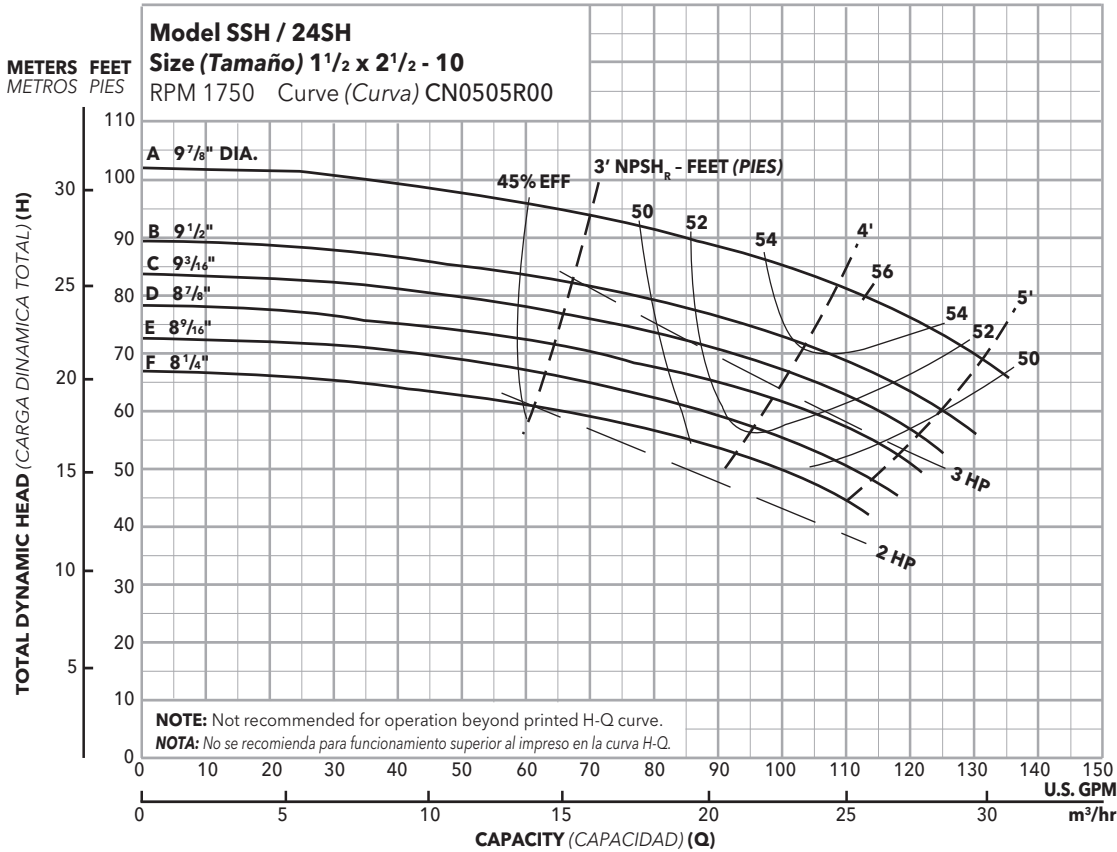

Optional Impeller, Impulsor Opcional		
Impeller Code, Código del Impulsor	Dia., Diá.	Standard HP Rating, Estándar HP Potencia
A	9 7/8"	5
B	9 1/2"	5
C	9 3/16"	3
D	8 7/8"	3
E	8 9/16"	3
F	8 1/4"	2

NOTE: Pump will pass a sphere to 5/16" diameter.
 NOTA: La bomba pasará una esfera a 5/16" diámetro.

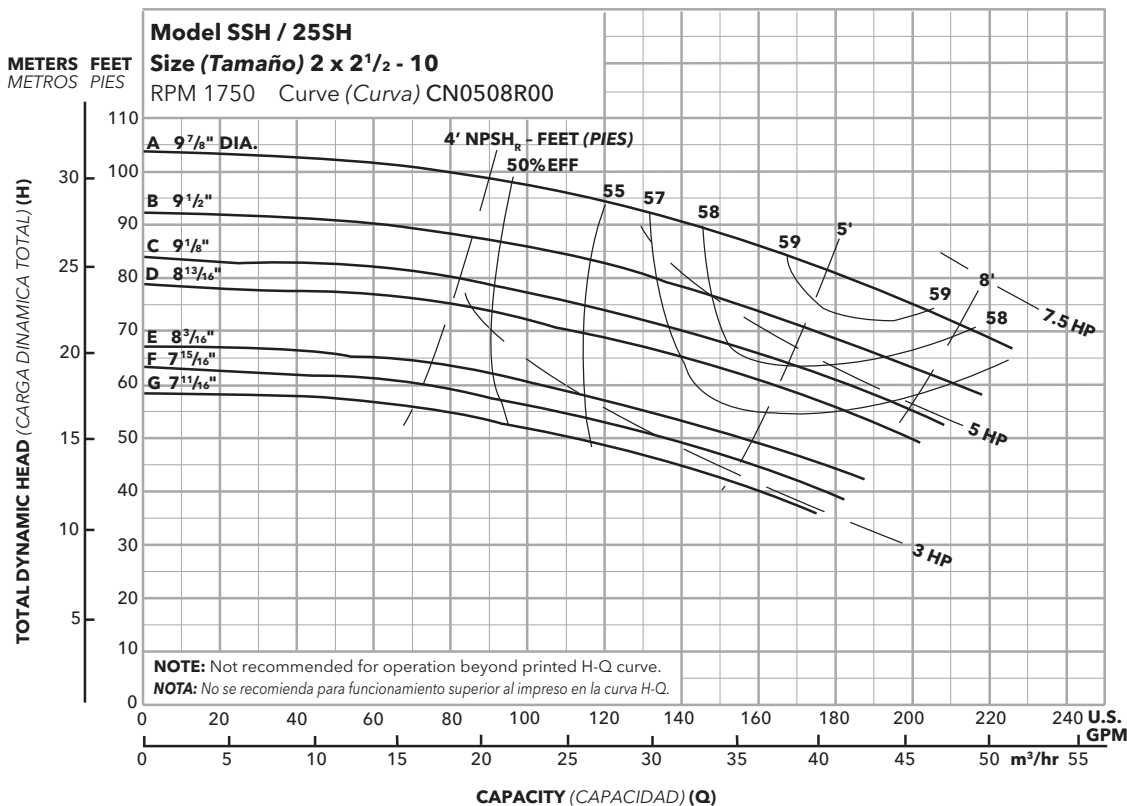

Optional Impeller, Impulsor Opcional		
Impeller Code, Código del Impulsor	Dia., Diá.	Standard HP Rating, Estándar HP Potencia
A	9 7/8"	7 1/2
B	9 1/2"	5
C	9 1/8"	5
D	8 13/16"	5
E	8 3/16"	3
F	7 15/16"	3
G	7 11/16"	3

NOTE: Pump will pass a sphere to 1/2" diameter.
 NOTA: La bomba pasará una esfera a 1/2" diámetro.

Commercial Water

PERFORMANCE CURVES - 60 HZ, 1725 RPM CURVAS DE FUNCIONAMIENTO - 60 HZ, 1725 RPM

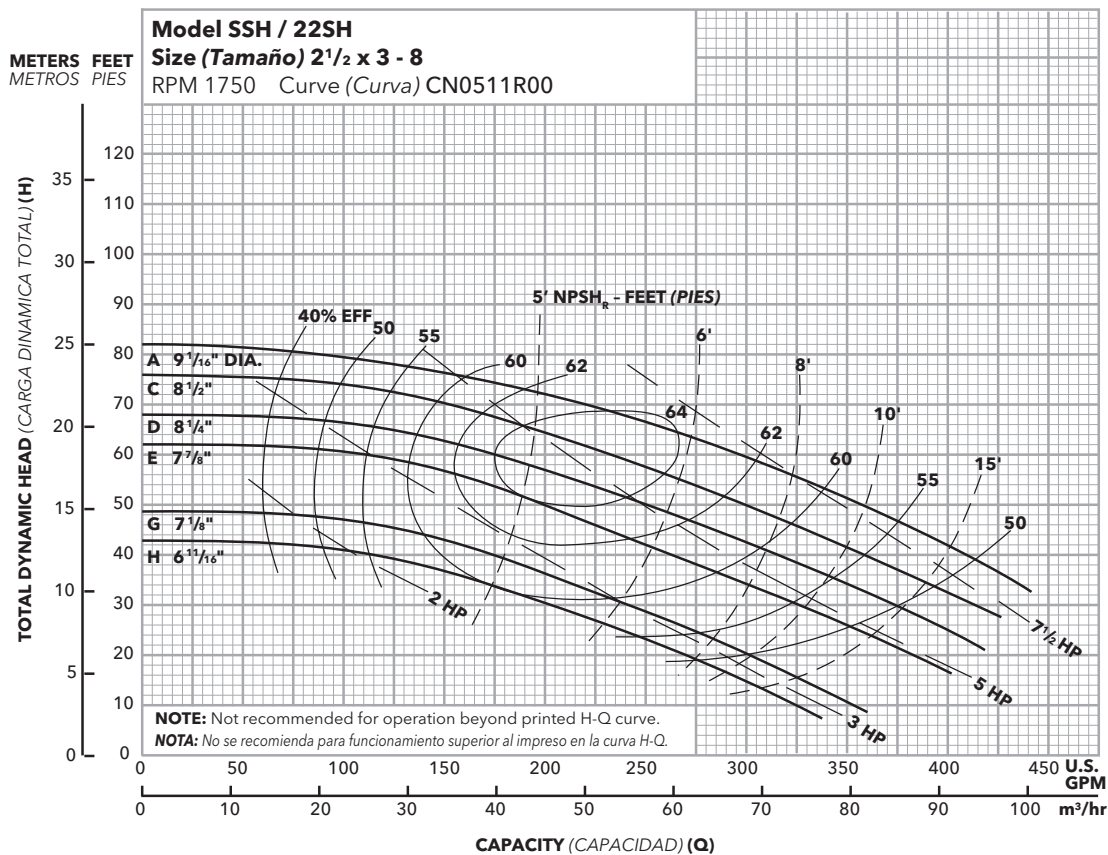

Optional Impeller, Impulsor Opcional		
Impeller Code, Código del Impulsor	Dia., Diá.	Standard HP Rating, Estándar HP Potencia
A	9 1/16"	7 1/2
C	8 1/2"	7 1/2
D	8 1/4"	5
E	7 7/8"	5
G	7 1/8"	3
H	6 1 1/16"	3

NOTE: Pump will pass a sphere to 1 9/32" diameter.

NOTA: La bomba pasará una esfera a 1 9/32" diámetro.

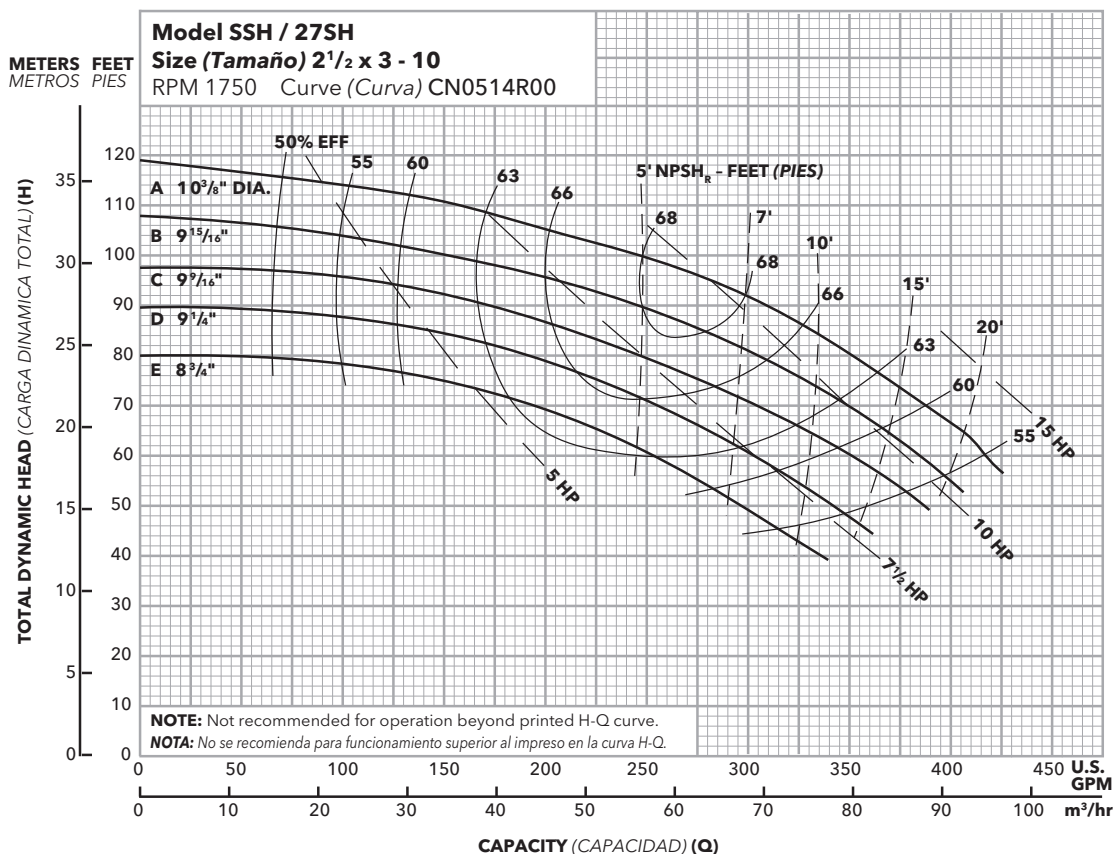

Optional Impeller, Impulsor Opcional		
Impeller Code, Código del Impulsor	Dia., Diá.	Standard HP Rating, Estándar HP Potencia
A	10 3/8"	15
B	9 15/16"	10
C	9 7/16"	10
D	9 1/4"	7 1/2
E	8 3/4"	7 1/2

NOTE: Pump will pass a sphere to 1 9/32" diameter.

NOTA: La bomba pasará una esfera a 1 9/32" diámetro.

PERFORMANCE CURVES - 60 HZ, 1725 RPM CURVAS DE FUNCIONAMIENTO - 60 HZ, 1725 RPM

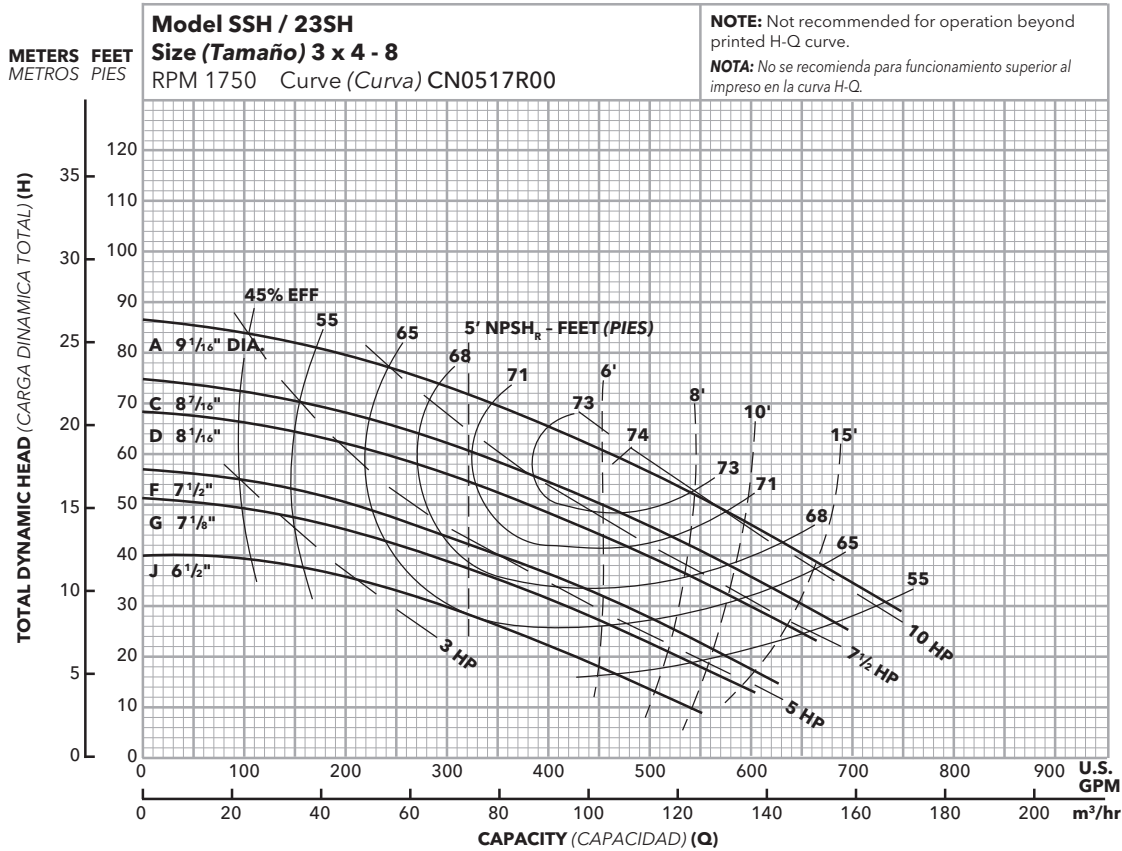

Optional Impeller, Impulsor Opcional

Impeller Code, Código del Impulsor	Dia., Diá.	Standard HP Rating, Estándar HP Potencia
A	9 1/16"	10
C	8 7/16"	7 1/2
D	8 1/16"	7 1/2
F	7 1/2"	5
G	7 1/8"	5
J	6 1/2"	3

NOTE: Pump will pass a sphere to 1/2" diameter.
NOTA: La bomba pasará una esfera a 1/2" diámetro.

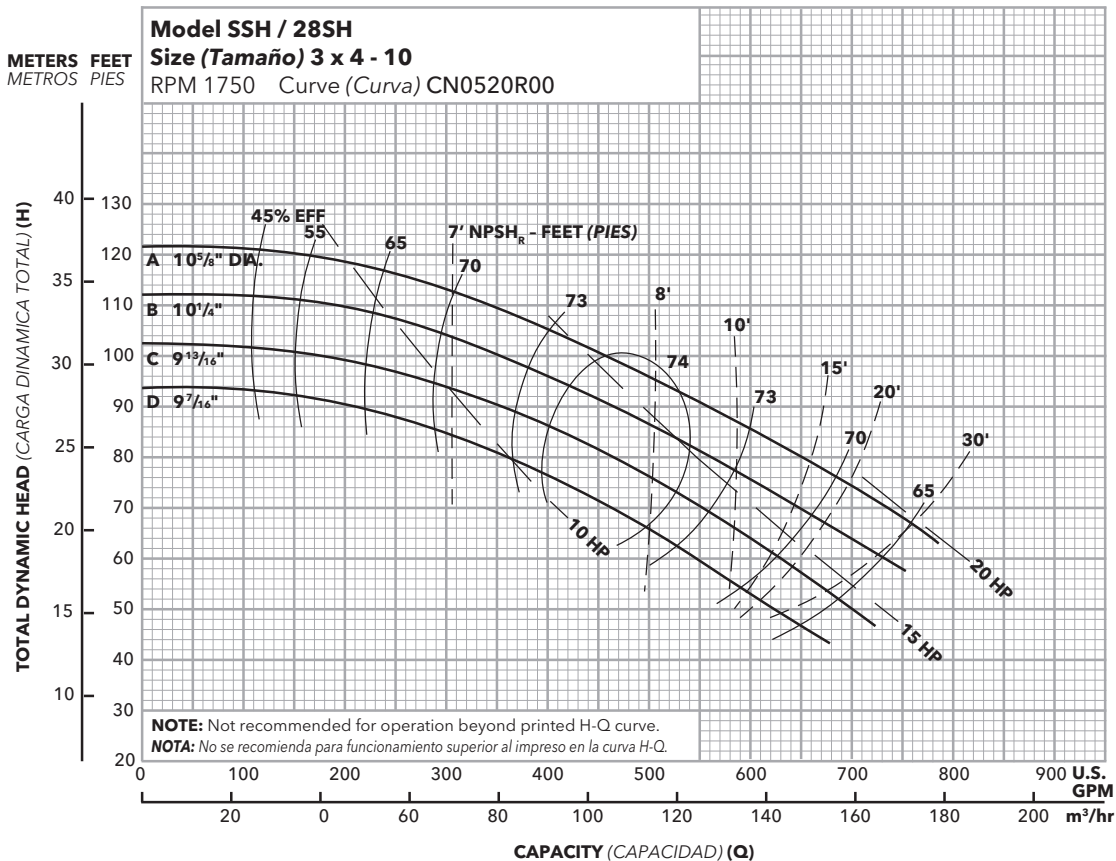

Optional Impeller, Impulsor Opcional

Impeller Code, Código del Impulsor	Dia., Diá.	Standard HP Rating, Estándar HP Potencia
A	10 5/16"	20
B	10 1/4"	15
C	9 13/16"	15
D	9 7/16"	15

NOTE: Pump will pass a sphere to 3/4" diameter.
NOTA: La bomba pasará una esfera a 3/4" diámetro.

PERFORMANCE CURVES - 50 HZ, 2900 RPM CURVAS DE FUNCIONAMIENTO - 50 HZ, 2900 RPM

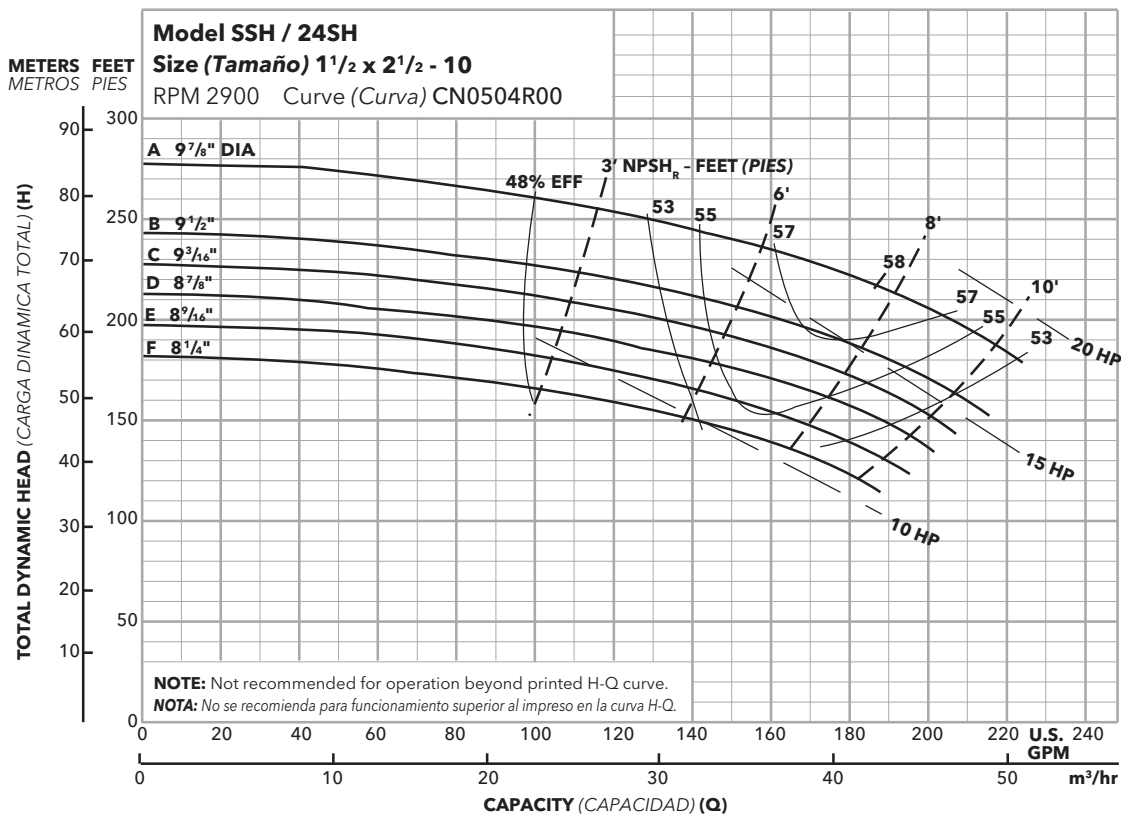

Optional Impeller, Impulsor Opcional		
Impeller Code, Código del Impulsor	Dia., Diá.	Standard HP Rating, Estándar HP Potencia
A	9 7/8"	20
B	9 1/2"	15
C	9 3/16"	15
D	8 7/8"	15
E	8 3/16"	10
F	8 1/4"	10

NOTE: Pump will pass a sphere to 1/2" diameter.
 NOTA: La bomba pasará una esfera a 1/2" diámetro.

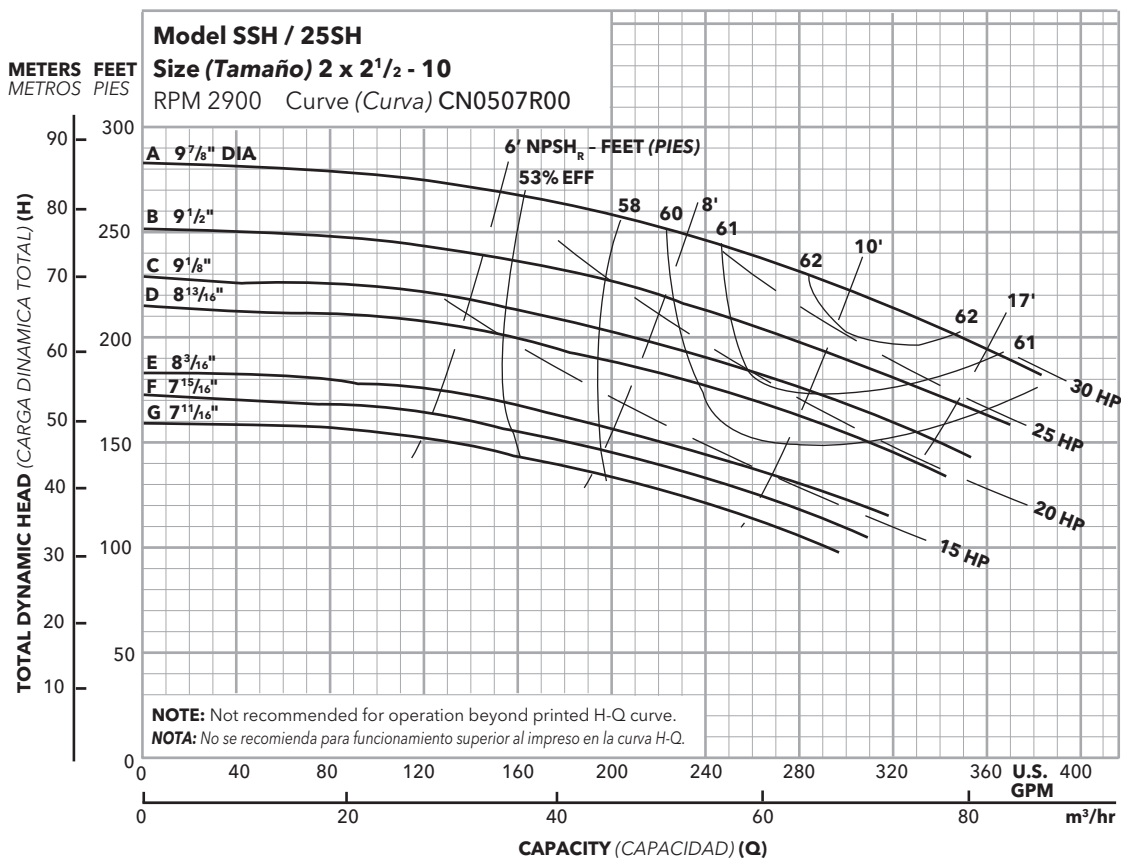

Optional Impeller, Impulsor Opcional		
Impeller Code, Código del Impulsor	Dia., Diá.	Standard HP Rating, Estándar HP Potencia
A	9 7/8"	30
B	9 1/2"	25
C	9 1/8"	20
D	8 13/16"	20
E	8 3/16"	15
F	7 15/16"	15
G	7 11/16"	15

NOTE: Pump will pass a sphere to 5/16" diameter.
 NOTA: La bomba pasará una esfera a 5/16" diámetro.

PERFORMANCE CURVES - 50 HZ, 2900 RPM CURVAS DE FUNCIONAMIENTO - 50 HZ, 2900 RPM

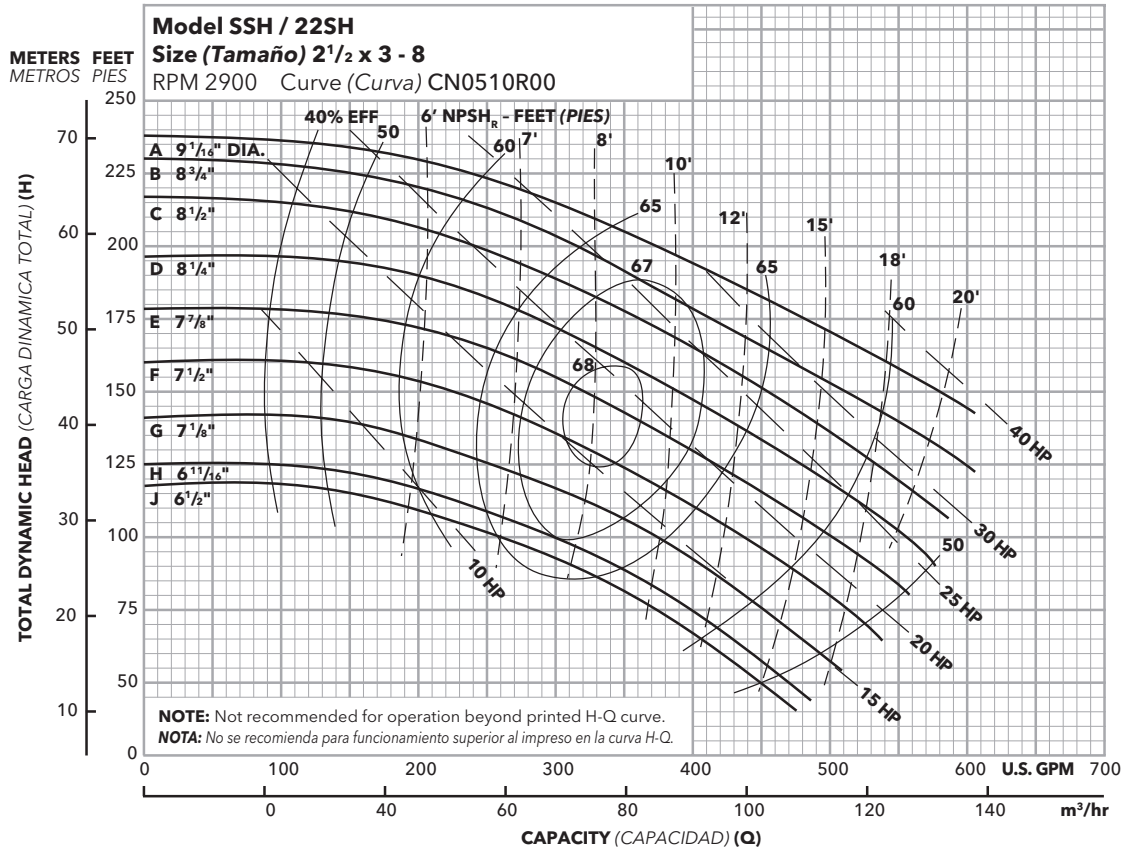

Optional Impeller, Impulsor Opcional		
Impeller Code, Código del Impulsor	Dia., Diá.	Standard HP Rating, Estándar HP Potencia
A	9 1/16"	40
B	8 3/4"	30
C	8 1/2"	30
D	8 1/4"	25
E	7 7/8"	20
F	7 1/2"	20
G	7 1/8"	15
H	6 11/16"	15
J	6 1/2"	15

NOTE: Pump will pass a sphere to 1 1/32" diameter.
NOTA: La bomba pasará una esfera a 1/32" diámetro.

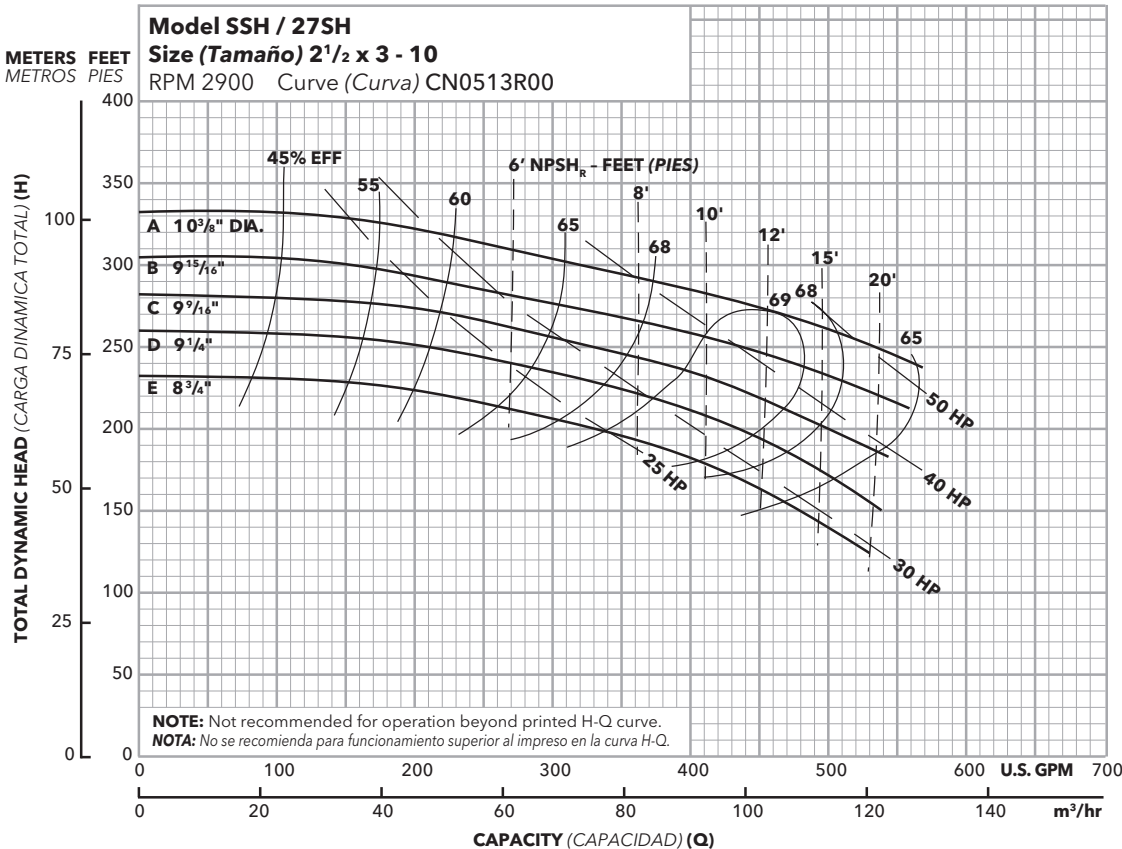

Optional Impeller, Impulsor Opcional		
Impeller Code, Código del Impulsor	Dia., Diá.	Standard HP Rating, Estándar HP Potencia
A	10 3/8"	50
B	9 15/16"	40
C	9 1/16"	40
D	9 1/4"	30
E	8 3/4"	30

Pump will pass a sphere to 1 1/32" diameter.
NOTA: La bomba pasará una esfera a 1/32" diámetro.

PERFORMANCE CURVES - 50 HZ, 2900 RPM CURVAS DE FUNCIONAMIENTO - 50 HZ, 2900 RPM

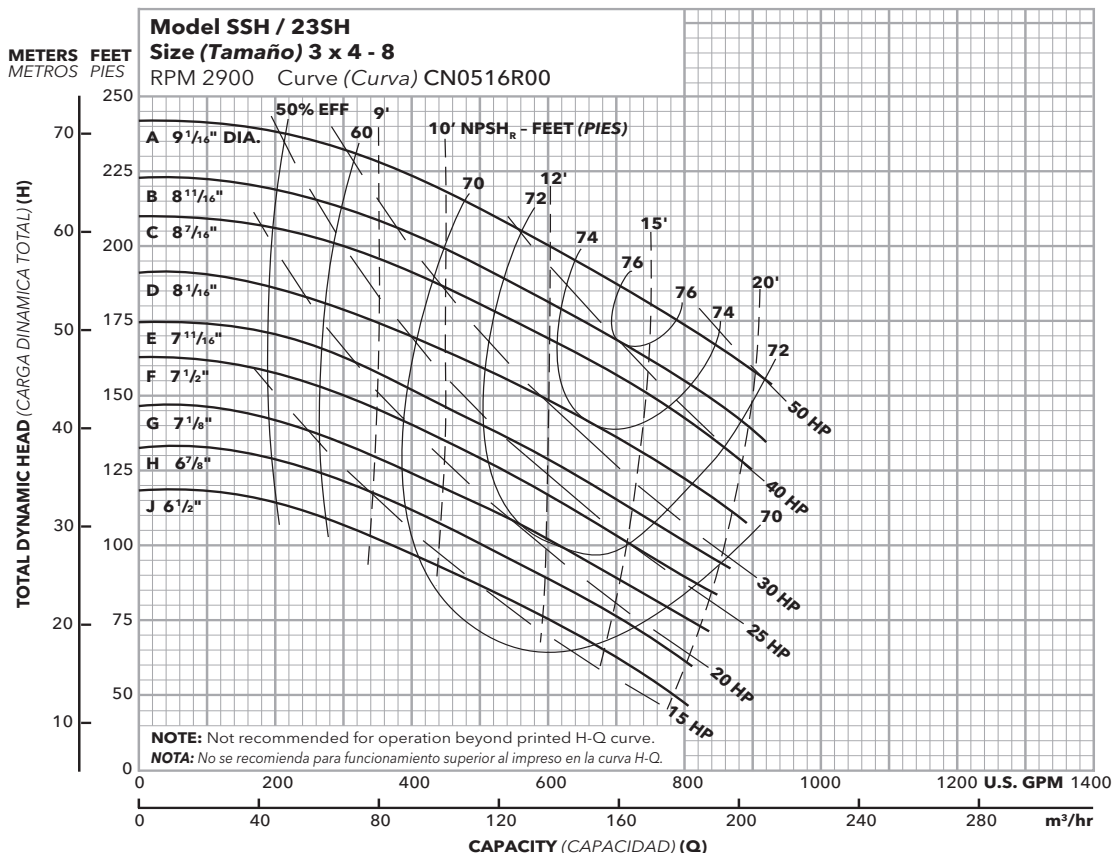

Optional Impeller, Impulsor Opcional		
Impeller Code, Código del Impulsor	Dia., Diá.	Standard HP Rating, Estándar HP Potencia
A	9 ¹ / ₁₆ "	50
B	8 ¹¹ / ₁₆ "	40
C	8 ⁷ / ₁₆ "	40
D	8 ¹ / ₁₆ "	30
E	7 ¹¹ / ₁₆ "	30
F	7 ¹ / ₂ "	25
G	7 ¹ / ₈ "	20
H	6 ⁷ / ₈ "	20
J	6 ¹ / ₂ "	15

NOTE: Pump will pass a sphere to 1/2" diameter.

NOTA: La bomba pasará una esfera a 1/2" diámetro.

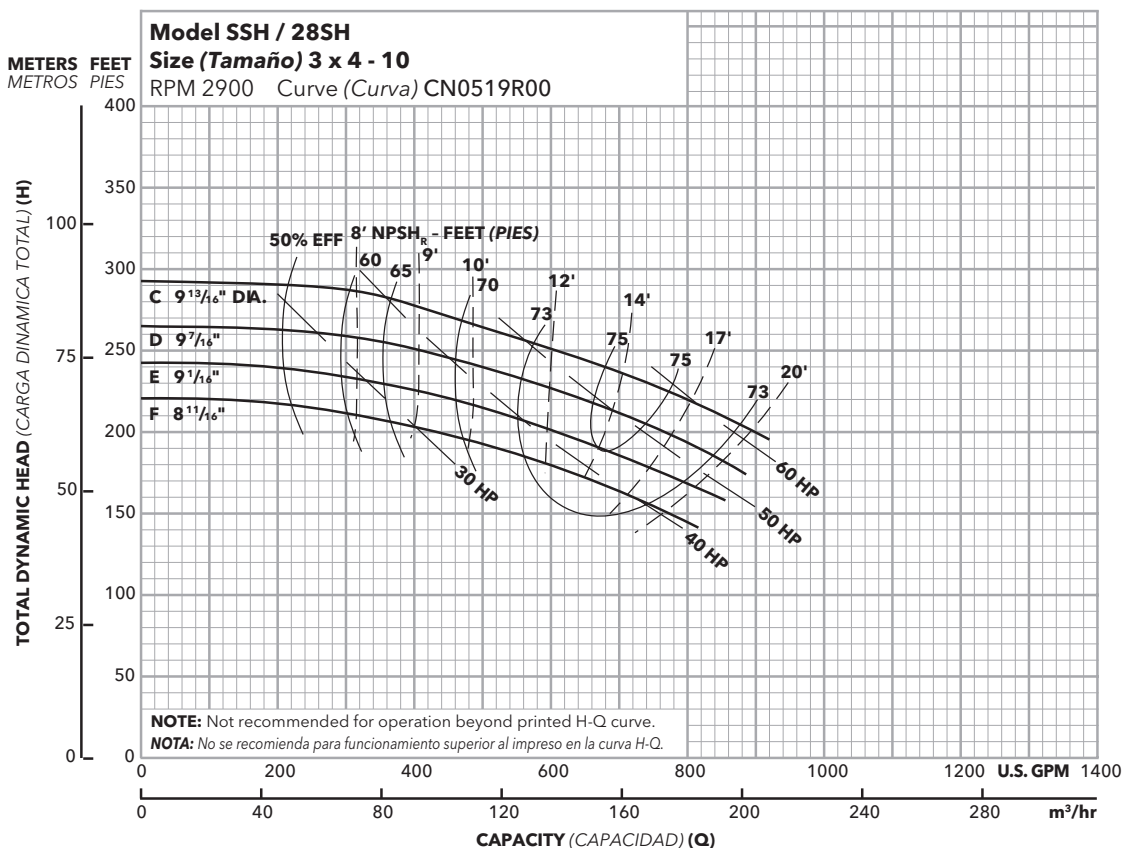

Optional Impeller, Impulsor Opcional		
Impeller Code, Código del Impulsor	Dia., Diá.	Standard HP Rating, Estándar HP Potencia
C	9 ¹³ / ₁₆ "	60
D	9 ⁷ / ₁₆ "	50
E	9 ¹ / ₁₆ "	50
F	8 ¹¹ / ₁₆ "	40

NOTE: Pump will pass a sphere to 3/4" diameter.

NOTA: La bomba pasará una esfera a 3/4" diámetro.

SSH CLOSE COUPLED - MATERIALS OF CONSTRUCTION SSH ACOUPLE CERRADO - MATERIALES DE CONSTRUCCIÓN

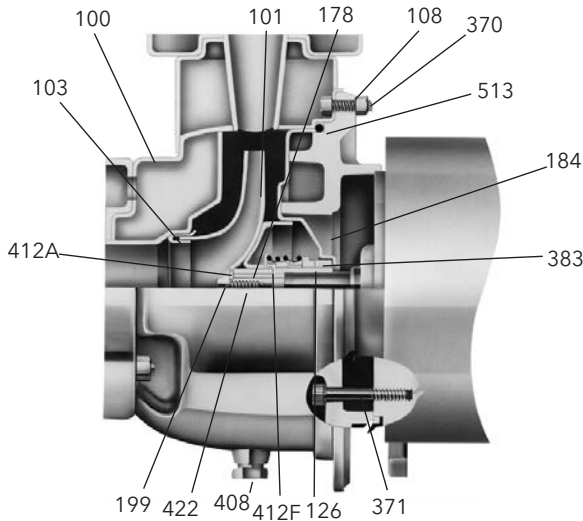

Item No., Parte No.	Description, Descripción	Materials, Materiales
100	Casing, Carcasa	
101	Impeller, Impulsor	
103	Wear ring, Anillo de desgaste	316L SS, 316L acero inox.
184	Seal housing, Alojamiento del sello	
126	Shaft sleeve, Camisa del eje	316 SS, 316 acero inox.
422	Impeller stud, Perno del impulsor	Steel, Acero
178	Impeller key, Llave del impulsor	Carbon steel, Acero al carbono
199	Impeller washer, Arandela del impulsor	316 SS, 316 acero inox.
370	Casing bolt with nut (casing to adapter), Tornillo de la carcasa con tuerca (carcasa para adaptador)	316L SS, 316L acero inoxidable
108	Adapter, Adaptador	Cast iron ASTM A48 CL20, Hierro fundido ASTM A48CL20
371	Hex head cap screw (adapter to motor), Tornillo de cabeza hexagonal (adaptador para motor)	Steel SAE 1200 series, Acero SAE series 1200
412A	O-ring, Impeller, Anillo en O, impulsor	
412F	O-ring, shaft sleeve, Anillo en O, camisa del eje	Viton
513	O-ring, Anillo 'O'	
408	Drain plug - 3/8 BSP, Válvula de drenaje - 3/8 BSP	316L SS, 316 acero inoxidable
383	Mechanical seal, Sello mecánico	See seal chart, Ver tabla del sello

SSH FRAME MOUNTED - MATERIALS OF CONSTRUCTION SSH ARMazón MONTADO - MATERIALES DE CONSTRUCCIÓN

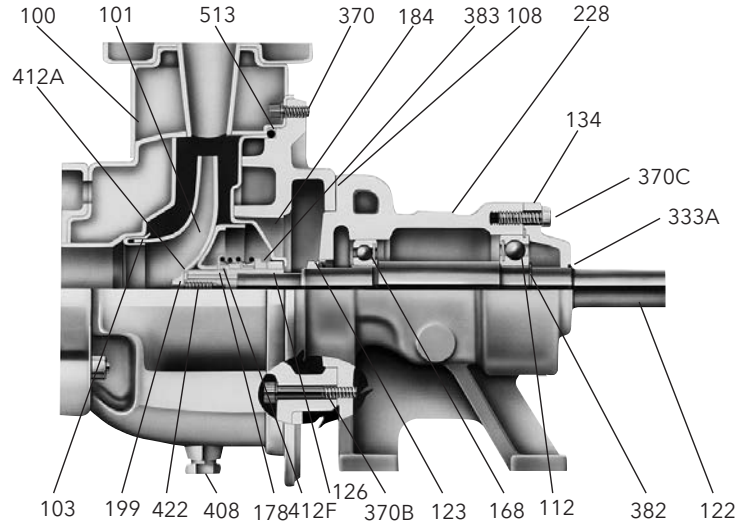

Item No., Parte No.	Description, Descripción	Materials, Descripción
100	Casing, Carcasa	
101	Impeller, Impulsor	316L SS,
103	Wear ring, Anillo de desgaste	316L acero inox.
184	Seal housing, Alojamiento del sello	
126	Shaft sleeve, Camisa del eje	316 SS, 316 acero inox.
178	Impeller key, Llave del impulsor	Carbon steel, Acero al carbono
422	Impeller Stud, Perno del impulsor	
199	Impeller washer, Arandela del impulsor	316 SS, 316 acero inox.
370	Casing bolt with nut, Tornillo de la carcasa con tuerca	316L SS,
408	Drain plug - 3/8 NPT, Válvula de drenaje - 3/8 NPT	316L acero inox.
513	O-ring, Anillo 'O'	Viton
383	Mechanical seal, Sello mecánico	See seal chart, Ver tabla del sello
108	Adapter, Adaptador	Cast iron ASTM A48CL20, Hierro fundido ASTM A48CL20
228	Bearing frame, Armazón de balineras	Cast iron ASTM A48CL20, Hierro fundido ASTM A48CL20
134	Bearing cover, Cubierta de balineras	
122	Pump shaft, Eje de la bomba	Carbon steel, Acero al carbono
168	Ball bearing (inboard), Balineras de bolas (interior)	
112	Ball bearing (outboard), Balineras de bolas (exterior)	
382	Retaining ring, Anillo de sujeción	
370B	Hex head cap screw (adapter to bearing frame), Tornillo de cabeza hexagonal (adaptador para armazón de balineras)	Steel, Acero
370C	Hex head cap screw (bearing frame to cover), Tornillo de cabeza hexagonal (armazón de balineras para cubierta)	
333A	Lip seal, Sello cubierto	BUNA-N
193	*Grease fitting, Accesorio de grasa	Steel, Acero
123	V-ring deflector, Deflector anillo 'V'	BUNA-N

Mechanical Seal, Sello Mecánico

John Crane Type 21 Mechanical Seal, Sello Mecánico John Crane Tipo 21							
Item, Parte	Part No., Pieza Número		Rotary, Rotativo	Stationary, Estacionario	Elastomers, Elastómeros	Metal Parts, Partes Metálicas	Intended Duty, Servicio Propuesto
	180-210 Frames, Armazones	250-360 Frames, Armazones					
383 Options, 383 Opciones	10K19	10K20	Carbon, Carbone	Silicon Carbide, Carburo de silicona	EPR	316 SS, 316 Acero inoxidable	Hot Water, Agua Caliente
	10K27	10K45					Mild Abrasive, Abrasivo Suave
	10K64	10K65	Sil-Carb.	Severe Duty, Deber Severo			

* M-Group only

SSH - ENGINEERING DATA SSH - INFORMACIÓN TÉCNICA

S-GROUP GRUPO-S

**Channel Steel Bedplate, Clockwise Rotation Viewed from Drive End;
Fundación de Acero, Rotación en Dirección de las Agujas del Reloj Visto desde el Extremo del Motor**

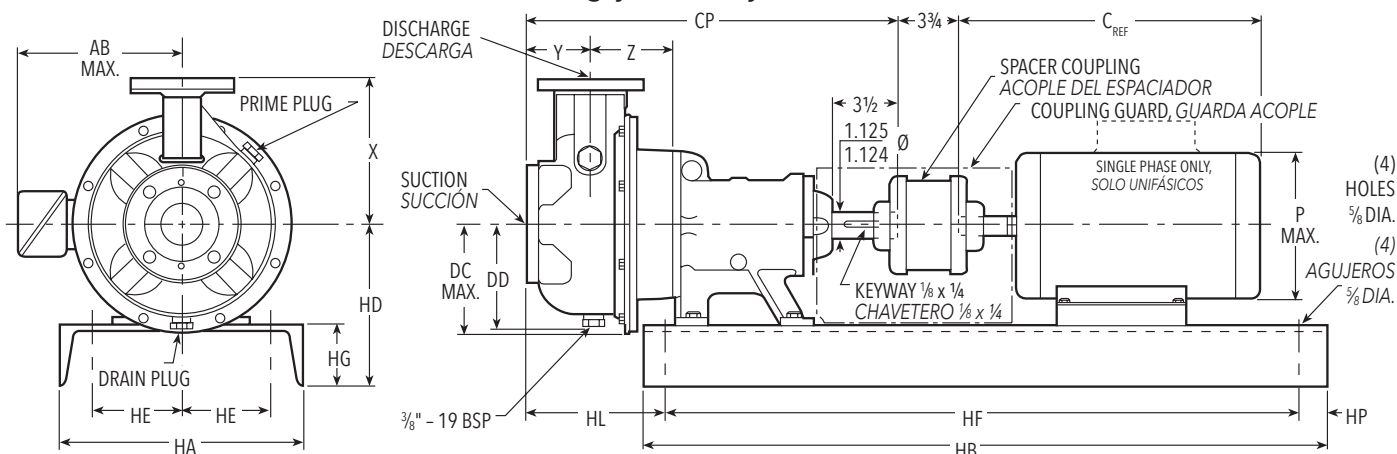

Dimensions and Weights - Determined by Pump, Dimensiones y Pesos - Determinados por la Bomba

Pump, Bomba	Suction*, Succión*	Discharge*, Descarga*	CP	DC Max., DC Máx.	DD	X	Y	Z	Wt. (lbs.), Peso (lib.)	Dimension "HL" Determined by Pump and Bedplate, Dimensión "HL" determinada la bomba y el motor						
										143/ 145	183/ 184	213/ 215	254/ 256	284/ 286		
9SH 1 X 2-6	2	1	16 3/4	5	4 3/4	6 3/8	3 3/8	3 3/8	56	9 1/8	7 7/8	3 3/8	Motor Frame Size, Tamaño del bastidor del motor			
10SH 1 X 2-8				5 5/8	5 5/8	7 7/8			64							
11SH 1 X 2-10				17 1/16	6 7/8	6 5/8			8 7/8				86	10	8 1/2	4 3/4
4SH 1 1/2 X 2 1/2-6	2 1/2	1 1/2	16 5/16	5	4 3/4	6 3/8	3 3/4	3 3/4	57	9 1/4	7 3/4	4				
7SH 1 1/2 X 2 1/2-8				5 5/8	5 5/8	7 7/8			66							
5SH 2 X 2 1/2-6				17 3/16	5	4 3/4			7 7/8				57	10	8 1/2	4 3/4
8SH 2 X 2 1/2-8				6	5 3/4	7 15/16			68							
6SH 2 1/2 X 3-6				3	2 1/2	6			5 3/4				7 15/16	59		

NOTES:

- All pumps shipped in vertical discharge position. May be rotated in 90° increments. Tighten 3/8" - 16 casing bolts to 12 ft./lbs. torque.
- Dimensions in inches.
- Motor dimensions may vary with motor manufacturer.
- Not to be used for construction purposes.

NOTAS:

- Todas las bombas transportadas en posición de descarga vertical. Pueden rotarse en aumentos de 90°. Apretar 3/8" - 16 tornillos de carcasa a 12 pies/libras potencia.
- Las dimensiones en pulgadas.
- Las dimensiones puede que varíen con los fabricantes.
- No para propósitos de construcción.

* For use with ANSI Class 150 mating flanges.
* Para usar con bridas que casan ANSI clase 150.

Available Motor and Bedplate Dimensions and Weights, Pesos y Dimensiones Disponibles de la Fundación y del Motor

Motor Frame, Armazón del Motor	HP @ 3500 RPM, HP a 3500 RPM				HP @ 1750 RPM, HP a 1750 RPM				AB Max., AB Máx.	C _{REF}	P Max., P Máx.	Wt. Max., Peso Máx.	Bedplate Data, Datos de la Fundación									
	Single Phase, Monofásicos		Three Phase, Trifásicos		Single Phase, Monofásicos		Three Phase, Trifásicos						HA	HB	HD**	HE	HF	HG	HP*	Wt. (lbs.), Peso (libras)	Motor Shim	Bearing Frame Shim
	ODP***	TEFC***	ODP***	TEFC***	ODP***	TEFC***	ODP***	TEFC***														
143T					1	1	1	1	5 1/4	13 3/8	6 5/8	45	10	28	8	3 3/4	24	2 3/4	3/4	48	1 3/4	-
145T	2	2	2-3	2	1 1/2	1 1/2	1 1/2-2	1 1/2-2		14 1/4		53										
182T	3	3	5	3	2	2	3	3		16 5/8		74										
184T	5	5	7 1/2	5	3 or 5	3	5	3	5 7/8	18 1/8	95	12	31	8 1/4	4 1/4	29	3	1	65	-	-	
213T			10	7 1/2					7 3/8	18	116											
215T			15	10					19 1/8	136												
254T			20	15					10 1/8	21 1/8	266	13	42	10 1/4	5 1/4	38 1/2	4	1 3/4	110	-	1	
256T			25	20					23 3/8	264												
284TS			30	25					12 5/8	24 7/8	392											
286TS			40	30					12 5/8	26 3/8	432	15	44	10 1/2	5 3/4	40 1/2	3 1/2	124	-	1 3/4		

Dimensions and weights vary with manufacturers. Dimensions in inches and weights in lbs.

** "HP" Dimensions at motor end only.

*** "HD" Dimension for 254T/256T motor frame on 1 x 2-10 only is 11"; A 3/4" motor shim and a 1 1/4" bearing frame shim are required.

*** Premium efficiency where required by Department of Energy regulations.

Dimensiones y pesos varían con los fabricantes. Dimensiones en pulgadas y pesos en libras.

* Dimensiones "HP" sólo en el extremo del motor.

** La dimensión "HD" para el bastidor del motor 254T/256T de 1 x 2 - 10 es sólo 11"; se requieren una cuña del motor de 3/4" y una cuña del bastidor de apoyo de 1 1/4".

*** Eficacia superior donde se requiera por el Ministerio de regulaciones de la Energía.

SSH-F - ENGINEERING DATA SSH-F - INFORMACIÓN TÉCNICA

**M-GROUP
GRUPO-M**

**Channel Steel Bedplate, Clockwise Rotation Viewed from Drive End;
Fundación de Acero, Rotación en Dirección de las Agujas del Reloj Visto desde el Extremo del Motor**

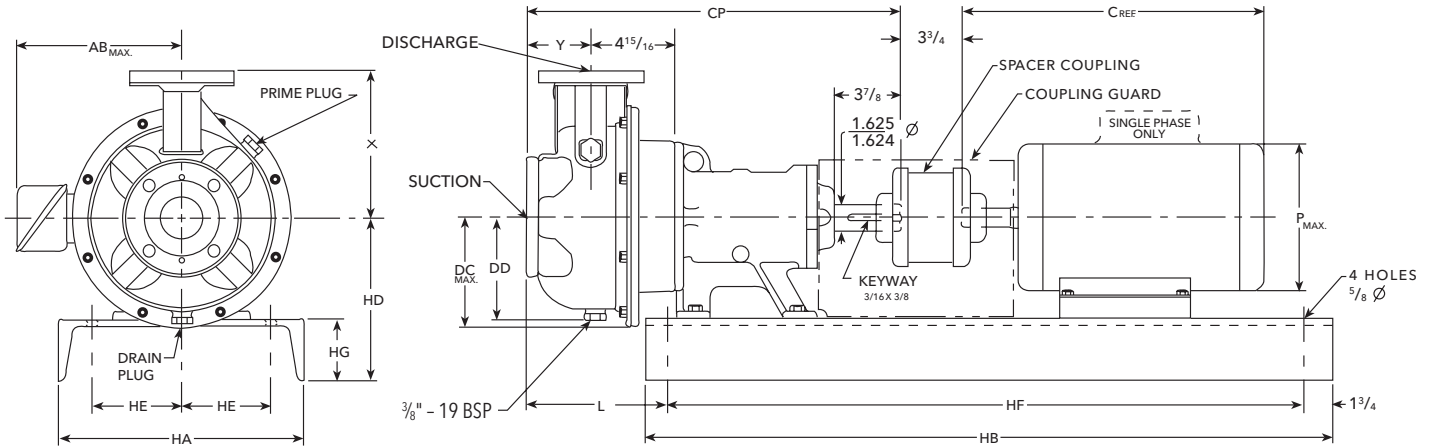

Dimensions and Weights - Determined by Pump, Dimensiones y Pesos - Determinados por la Bomba

Pump	Pump Size, Tamaño de la Bomba	Suction*, Succión*	Discharge*, Descarga*	CP	DC Max., DC Máx.	DD	L	X	Y	Wt. (lbs.), Peso (libras)
24SH	1½ x 2½-10	2½	1½	23	6 ^{7/8}	6 ^{5/8}	10 ^{1/8}	8 ^{15/16}	4	125
25SH	2 x 2½-10		2		6 ^{7/8}	5 ^{7/8}				125
22SH	2½ x 3-8	3	2½		6 ^{7/8}	6 ^{5/8}	11 ^{1/8}	9 ^{15/16}	5	125
27SH	2½ x 3-10				6 ^{7/8}	6 ^{5/8}				134
23SH	3 x 4-8	4	3	24	7 ^{7/8}	7 ^{7/8}	11 ^{1/8}	11 ^{1/8}	5	136
28SH	3 x 4-10				7 ^{7/8}	7 ^{7/8}	11 ^{1/8}	11 ^{1/8}	5	148

* For use with ANSI class 150 mating flanges.
* Para usar con bridas que casan ANSI clase 150.

NOTE:

1. Pumps will be shipped with top vertical discharge as standard. For other orientations, remove casing bolts, rotate discharge to desired position and tighten 3/8" - 16 bolts to 12 ft./lbs.
2. ALL dimensions in inches.
3. Not for construction purposes.

NOTA:

1. Las bombas se transportarán con la descarga vertical superior como estándar. Para otras orientaciones, retirar los tornillos de la carcasa, rotar la descarga a la posición deseada, y apretar 3/8" - 16 tornillos a 12 pies/libras.
2. TODAS las dimensiones en pulgadas.
3. No para propósitos de construcción.

Available Motor and Bedplate Dimensions and Weights, Pesos y Dimensiones Disponibles de la Fundación y del Motor

Motor Frame, Armazón del Motor	HP @ 3500 RPM		HP @ 1750 RPM - T-Frame Only				AB Max., AB Máx.	C Ref.	P Max., P Máx.	Wt. Max., Peso Máx.	Bedplate Data, Datos de la Fundación						
	Three Phase, Trifásicos		Single Phase, Monofásicos		Three Phase, Trifásicos						HA	HB	HD	HE	HF	HG	Wt. (lbs.), Peso (libras)
	ODP	TEFC	ODP	TEFC	ODP	TEFC											
184T			3 or 5	3	5	5	5 ^{7/8}	18 ^{1/8}	7 ^{7/8}	95							
213T					7½	7½	7 ^{3/8}	18	9 ^{1/8}	116	13	42	10¼	5¼	38½	4	111
215T	15				10	10		19 ^{1/8}		136							
254T	20	15			15	15	21 ^{1/8}	266									
256T	25	20			20	20	23 ^{3/8}	264									
284TS/T	30	25			25	25	12 ^{5/8}	24 ^{7/8}	15	392	15	44	10½	5¾	40½	3½	124
286TS/T	40	30					26 ^{5/8}	422									
324TS/T	50	40					14 ^{1/8}	28¾	17 ^{3/8}	592	18	48	12	7¼	44½	4	183
326TS/T	60	50					30¼	634									
364TS/T	75	60					31 ^{1/8}	834									
365TS/T	100	75					32 ^{5/8}	1000									
405TS/T		100					18	36 ^{7/8}	20 ^{5/8}	1060	22	56	14	7¼	52½	4	214

Dimensions and weights vary with manufacturers. Dimensions in inches and weights in lbs.
Dimensiones y pesos varían con los fabricantes. Dimensiones en pulgadas y pesos en libras.

SSH CLOSE COUPLED - DIMENSIONS AND WEIGHTS SSH ACOPLE CERRADO - DIMENSIONES Y PESOS

S-GROUP GRUPO-S

(All dimensions in inches and weights in lbs. Do not use for construction purposes.)
(Todas las dimensiones en pulgadas y pesos en libras. No usar para propósitos de construcción.)

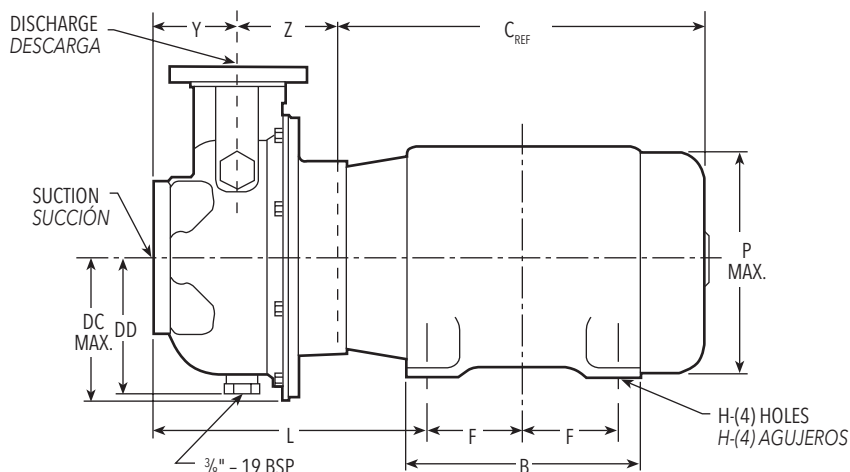
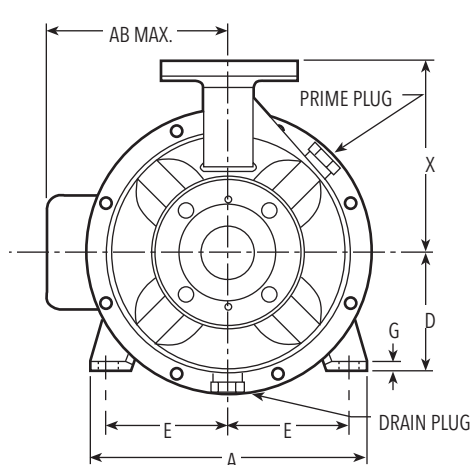

Pump, Bomba	150 lb. Flange, Brida de 150 lib.		DC Max., DC Máx.	DD	X	Y	Z	DIM. "L" (Motor Frame Size) DIM. "L" (Tamaño del Armazón del Motor)				Wt. (lbs.), Pesos (libras)	
	Suct.* Succ.*	Disch.* Desc.*						143/145	182/184	213/215	254/256		
9SH 1x2-6	2	1	5	4 ³ / ₄	6 ³ / ₈	3 ³ / ₈	3 ³ / ₈	9 ³ / ₈	10 ¹ / ₂	11 ¹ / ₂	-	24	
10SH 1x2-8			5 ⁵ / ₈	5 ⁵ / ₈	7 ¹ / ₈			-	32				
11SH 1x2-10	2 ¹ / ₂	1 ¹ / ₂	6 ¹ / ₈	6 ¹ / ₈	8 ¹ / ₈	4	3 ³ / ₈	10 ³ / ₄	11 ³ / ₈	12 ³ / ₈	12 ³ / ₈	54	
4SH 1 ¹ / ₂ x2 ¹ / ₂ -6			5	4 ³ / ₄	6 ³ / ₈	3 ¹ / ₄		9 ³ / ₄	10 ³ / ₈	11 ³ / ₈	-	25	
7SH 1 ¹ / ₂ x2 ¹ / ₂ -8			5 ⁵ / ₈	5 ⁵ / ₈	7 ¹ / ₈	4		3 ³ / ₈	10 ¹ / ₂	11 ¹ / ₈	12 ¹ / ₈	12 ¹ / ₈	34
5SH 2x2 ¹ / ₂ -6			5	4 ³ / ₄	7 ¹ / ₈								25
8SH 2x2 ¹ / ₂ -8	3	2 ¹ / ₂	6	5 ³ / ₄	7 ¹ / ₈	4	3 ³ / ₈	10 ¹ / ₂	11 ¹ / ₈	12 ¹ / ₈	12 ¹ / ₈	36	
6SH 2 ¹ / ₂ x3-6			4 ³ / ₄	7 ¹ / ₈	27								

* For use with ANSI class 150 mating flanges.
* Para usar con bridas que casan ANSI clase 150.

NOTE:

1. Pumps shipped in vertical discharge as standard. For other orientations, remove casing bolts, rotate discharge to desired position, and tighten ³/₈ - 16 bolts to 12 ft./lbs., ⁷/₁₆ - 14 bolts to 20 ft./lbs.
2. ALL dimensions in inches.
3. Motor dimensions may vary with motor manufacturer.
4. Not for construction purposes.

NOTA:

1. Las bombas se transportarán en descarga vertical como estándar. Para otras orientaciones, retirar los tornillos de la carcasa, rotar la descarga a la posición deseada, y apretar ³/₈ - 16 tornillos a 12 pies/libras, ⁷/₁₆ - 14 tornillos a 20 pies/libras.
2. TODAS las dimensiones en pulgadas.
3. Las dimensiones puede que varíen con los fabricantes.
4. No para propósitos de construcción.

Dimensions Determined by JM Motor Frame, Dimensiones Determinadas por el Armazón del Motor JM

JM Frame, JM Armazón	A	AB	B	D	E	F	G	C _{REF}	H Dia., H Diám.	P Max., P Máx.	Motor Wt. (lbs.) Peso Motor (lib.)
143JM	6 ¹ / ₂	5 ¹ / ₄	6	3 ¹ / ₂	2 ³ / ₄	2	1/8	11 ¹ / ₄	1 ¹ / ₃₂	6 ³ / ₈	41
145JM	8 ¹ / ₂	6 ⁷ / ₈	6 ¹ / ₂	4 ¹ / ₂	3 ³ / ₄	2 ¹ / ₄	3 ¹ / ₁₆	13 ¹ / ₂	1 ¹ / ₃₂	7 ⁷ / ₈	57
182JM						2 ³ / ₄					77
184JM	9 ¹ / ₂	7 ³ / ₈	8	5 ¹ / ₄	4 ¹ / ₄	3 ¹ / ₂	7 ¹ / ₃₂	15 ¹ / ₂	1 ¹ / ₃₂	9 ³ / ₈	97
213JM						3 ¹ / ₂					122
215JM						5					155
254TCZ	11 ¹ / ₄	9	9 ¹ / ₂	6 ¹ / ₄	5	4 ¹ / ₈	1/4	18 ⁵ / ₈	1 ¹ / ₃₂	11 ¹ / ₂	265
256TCZ			11 ³ / ₄			5					320

Motor Frame Selections, Selecciones del Armazón del Motor

Motor Frame, Armazón del Motor	Motor Horsepower, Potencia del Motor							
	3500 RPM, 3500 RPM				1750 RPM, 1750 RPM			
	1Ø, Monofásicos		3Ø, Trifásicos		1Ø, Monofásicos		3Ø, Trifásicos	
	ODP*	TEFC*	ODP*	TEFC*	ODP*	TEFC*	ODP*	TEFC*
143JM	-	-	-	-	-	-	1	1
145JM	2	2	2-3	2	1-1 ¹ / ₂	1-1 ¹ / ₂	1 ¹ / ₂ -2	1 ¹ / ₂ -2
182JM	3	3	5	3	2	2-3	3	3
184JM	5	5	7 ¹ / ₂	5	3	-	5	5
213JM	7 ¹ / ₂	-	10	7 ¹ / ₂	5	-	7 ¹ / ₂	7 ¹ / ₂
215JM	10	-	15	10-15	-	-	-	-
254TCZ	-	-	20	-	-	-	-	-
256TCZ	-	-	25	20	-	-	-	-

* Premium efficiency where required by Department of Energy regulations.
* Eficacia superior donde se requiera por el Ministerio de regulaciones de la Energía.

SSH CLOSE COUPLED - DIMENSIONS AND WEIGHTS SSH ACOUPLE CERRADO - DIMENSIONES Y PESOS

M-GROUP GRUPO-M

(All dimensions in inches and weights in lbs. Do not use for construction purposes.) (Todas las dimensiones en pulgadas y pesos en libras. No usar para propósitos de construcción.)

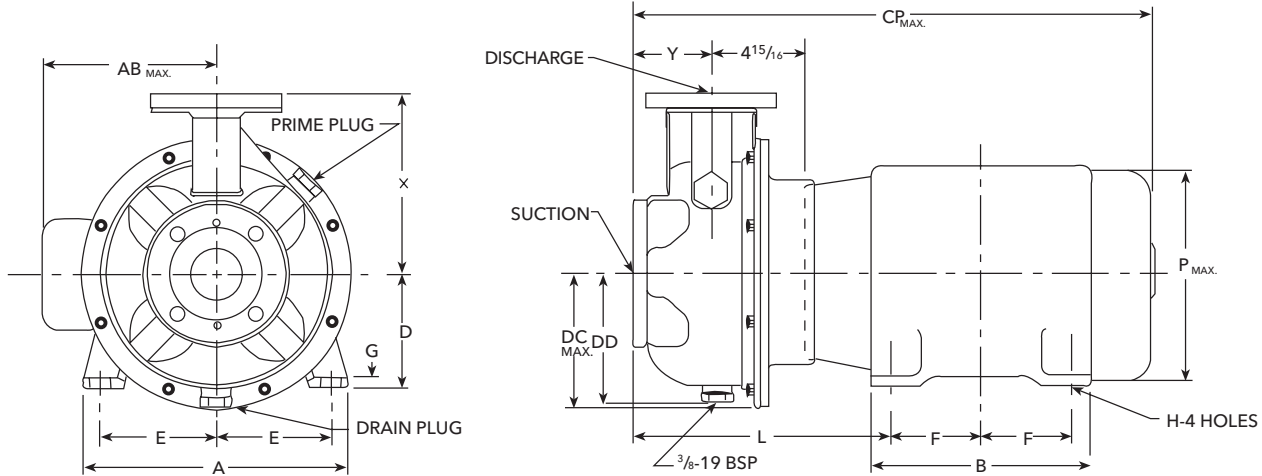

Dimensions "L" Determined by Pump and Motor, Dimensiones "L" Determinadas por la Bomba y el Motor

Pump	Pump Size, Tamaño de la Bomba	Suction*, Succión*	Discharge*, Descarga*	CP Max., CP Máx.	DC Max., DC Máx.	DD	X	Y	Wt. (lbs.), Peso (libras)	Motor Frame Size, Tamaño del Armazón del Motor					
										140	180	210	250	280	320
24SH	1 1/2 x 2 1/2-10	2 1/2	1 1/2	34 1/2	6 7/8	6 5/8	8 15/16	4	75	10 1/2	11 1/8	12 1/8	13 7/8	14 3/8	15
25SH	2 x 2 1/2-10		2	36	6 1/8	5 7/8			72	-					
22SH	2 1/2 x 3-8	3	2 1/2	36	6 1/8	5 7/8	8 15/16	4	72	-	11 1/8	12 1/8	13 7/8	14 3/8	15
27SH	2 1/2 x 3-10								-	-					
23SH	3 x 4-8	4	3	37	6 7/8	6 5/8	9 15/16	5	86	11 1/2	12 1/8	13 3/8	14 7/8	15 3/8	16
28SH	3 x 4-10								-	-					

* For use with ANSI class 150 mating flanges.

* Para usar con bridas que casan ANSI clase 150.

NOTES:

1. Pumps shipped in vertical discharge as standard. For other orientations, remove casing bolts, rotate discharge to desired position, and tighten 3/8 - 16 bolts to 12 ft./lbs., 7/16 - 14 bolts to 20 ft./lbs., 1/2 - 13 bolts to 35 ft./lbs.
2. Motor dimensions may vary with motor manufacturer.
3. Not for construction purposes.

NOTAS:

1. Las bombas se transportarán en descarga vertical como estándar. Para otras orientaciones, retirar los tornillos de la carcasa, rotar la descarga a la posición deseada, y apretar 3/8 - 16 tornillos a 12 pies/libras, 7/16 - 14 tornillos a 20 pies/libras, 1/2 - 13 tornillos a 35 pies/libras.
2. TODAS las dimensiones en pulgadas.
3. No para propósitos de construcción.

Dimensions Determined by JM Motor Frame, Dimensiones Determinadas por el Armazón del Motor JM

Frame, Armazón	A	AB Max.	B	D	E	F	G	H	P Max., P Máx.
145JM	6 1/2	5 1/4	6	3 1/2	2 3/4	2 1/2	1/8	1 1/32	7 3/16
182JM	8 1/2	5 7/8	6 1/2	4 1/2	3 3/4	2 1/4	3/16	1 1/32	8 1/2
184JM						2 3/4			
213JM	9 1/2	7 3/8	8	5 1/4	4 1/4	3 1/2	7/32	1 1/32	10 3/16
215JM						3 3/2			
254JM	11 1/4	9	11 3/4	6 1/4	5	4 1/8	1/4	1 1/32	13 1/4
256JM						5			
284JM	12 1/4	12 1/4	12 1/4	7	5 1/2	4 3/4	1/4	1 1/32	15
286JM						5 1/2			
324JM	14	13 1/4	14	8	6 1/4	5 1/4	5/16	2 1/32	16 15/16
326JM						6			
364TCZ	17 3/4	15 1/8	15 1/2	9	7	5 5/8	1	2 1/32	19
365TCZ						6 1/8			

364TCZ and 365TCZ frames are built with 326JM shaft extensions.

Dimensions may vary with manufacturer.

Las armazones 364TCZ y 365TCZ se construyen con extensiones del eje 326JM.

Las dimensiones puede que varíen con los fabricantes.

Motor Frame Selections, Selecciones del Armazón del Motor

Frame, Armazón	Motor Horsepower, Potencia del Motor						Wt. Max., Peso Máx.
	3500 RPM		1750 RPM				
	3 PH, Trifásicos	1 PH, Monofásicos	3 PH, Trifásicos				
	ODP*	TEFC*	ODP*	TEFC*	ODP*	TEFC*	
145JM	-	-	-	-	2	2	57
182JM	-	-	2	2, 3	3	3	77
184JM	-	-	3	-	5	5	97
213JM	10	-	5	-	7 1/2	7 1/2	141
215JM	15	10	-	-	10	10	155
254JM	20	15	-	-	15	15	265
256JM	25	20	-	-	20	20	320
284JM	30	25	-	-	25	25	419
286JM	40	30	-	-	-	-	422
324JM	50	40	-	-	-	-	562
326JM	60	50	-	-	-	-	625
364TCZ	75	60	-	-	-	-	775
365TCZ	100	75, 100	-	-	-	-	905

364TCZ and 365TCZ frames are built with 326JM shaft extensions.

Las armazones 364TCZ y 365TCZ se construyen con extensiones del eje 326JM.

* Premium efficiency where required by Department of Energy regulations.

* Eficacia superior donde se requiera por el Ministerio de regulaciones de la Energía.

SSH FRAME MOUNTED - DIMENSIONS AND WEIGHTS SSH ARMAZÓN MONTADO - DIMENSIONES Y PESOS

S-GROUP GRUPO-S

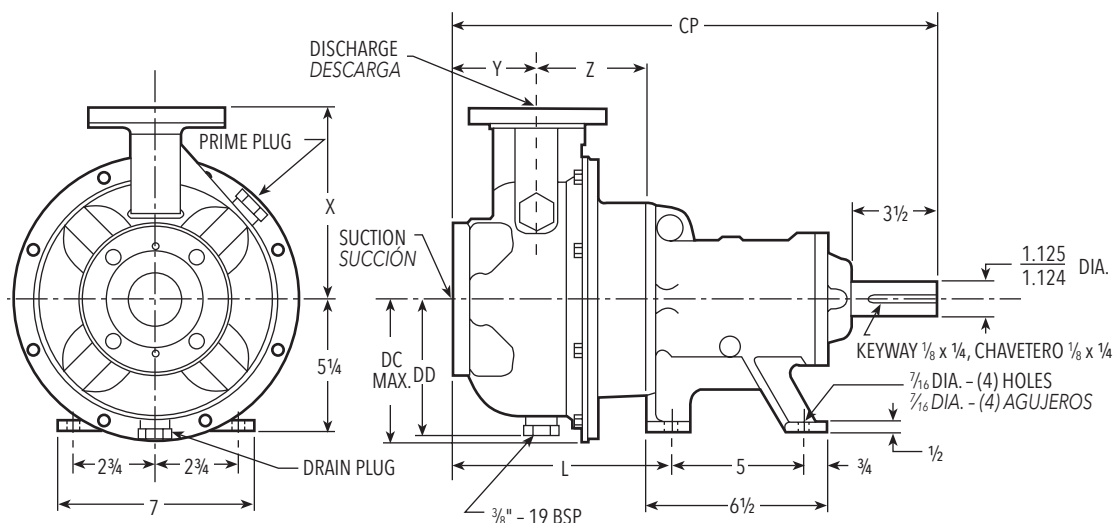

Dimensions and Weights - Bare Pump Only, Dimensiones y Pesos - Solamente Bomba

Pump, Bomba	150 lb. Flange, Brida de 150 lib.		DC Max., DC Máx.	DD	CP Max., CP Máx.	L	X	Y	Z	Wt. (lbs.), Peso (libras)	
	Suction*, Succión*	Discharge*, Descarga*									
9SH 1 x 2 - 6	2	1	5	4 ³ / ₄	16 ³ / ₄	7 ⁷ / ₈	6 ³ / ₈	3 ³ / ₈	3 ³ / ₈	56	
10SH 1 x 2 - 8			5 ⁵ / ₈	5 ³ / ₈	7 ⁷ / ₈	7 ⁷ / ₈	7 ⁷ / ₈			64	
11SH 1 x 2 - 10			6 ⁶ / ₈	6 ⁶ / ₈	17 ⁷ / ₁₆	8 ³ / ₄	8 ⁷ / ₈	4		86	
4SH 1 ¹ / ₂ x 2 ¹ / ₂ - 6	2 ¹ / ₂	1 ¹ / ₂	5	4 ³ / ₄	16 ⁷ / ₁₆	7 ³ / ₄	6 ³ / ₈	3 ³ / ₄	3 ³ / ₈	57	
7SH 1 ¹ / ₂ x 2 ¹ / ₂ - 8			5 ⁵ / ₈	5 ³ / ₈	17 ⁷ / ₁₆	7 ³ / ₄	6 ³ / ₈			3 ³ / ₄	65
5SH 2 x 2 ¹ / ₂ - 6			2	5	4 ³ / ₄	17 ⁷ / ₁₆	8 ¹ / ₂	7 ⁷ / ₈		4	57
8SH 2 x 2 ¹ / ₂ - 8				6	5 ³ / ₄						7 ¹⁵ / ₁₆
6SH 2 ¹ / ₂ x 3 - 6	3	2 ¹ / ₂	6	5 ³ / ₄					59		

* For use with ANSI class 150 mating flanges.

* Para usar con bridas que casan ANSI clase 150.

NOTE:

- Pumps will be shipped with top vertical discharge as standard. For other orientations, remove casing bolts, rotate discharge to desired position, and tighten ³/₈-16 bolts to 12 ft./lbs., ⁷/₁₆-14 bolts to 20 ft./lbs.
- ALL dimensions in inches.
- Not for construction purposes.

NOTA:

- Las bombas se transportarán con la descarga vertical superior como estándar. Para otras orientaciones, retirar los tornillos de la carcasa, rotar la descarga a la posición deseada, y apretar ³/₈-16 tornillos a 12 pies/libras, ⁷/₁₆-14 tornillos a 20 pies/libras.
- TODAS las dimensiones en pulgadas.
- No para propósitos de construcción.

SSH FRAME MOUNTED - DIMENSIONS AND WEIGHTS SSH ARMazón MONTADO - DIMENSIONES Y PESOS

**M-GROUP
GRUPO-M**

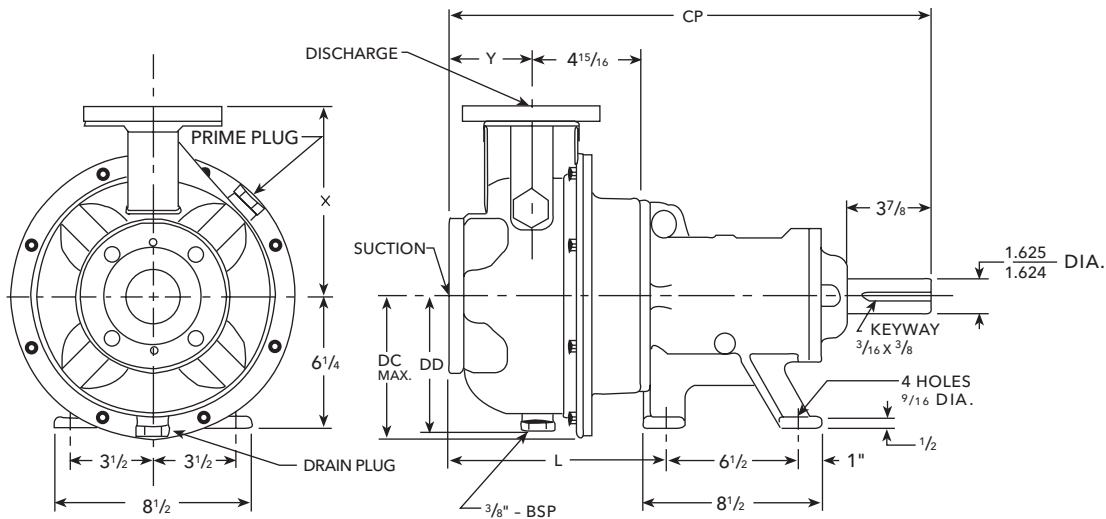

Dimensions and Weights - Bare Pump Only, Dimensiones y Pesos - Solamente Bomba

Pump	Pump Size, Tamaño de la Bomba	Suction*, Succión*	Discharge*, Descarga*	CP	DC Max., DC Máx.	DD	L	X	Y	Wt. (lbs.), Peso (libras)
24SH	1½ x 2½-10	2½	1½	23	6⅞	6⅝	10¼	8⅞	4	125
25SH	2 x 2½-10		2		6⅞	5⅞				125
22SH	2½ x 3-8	3	2½		6⅞	6⅝		9⅞		125
27SH	2½ x 3-10				6⅞	6⅝				134
23SH	3 x 4-8	4	3	24	7⅞	7⅞	11¼	5	136	
28SH	3 x 4-10								148	

* For use with ANSI class 150 mating flanges.

* Para usar con bridas que casan ANSI clase 150.

NOTES:

- Pumps will be shipped with top vertical discharge as standard. For other orientations, remove casing bolts, rotate discharge to desired position, replace and tighten ⅜-16 bolts to 12 ft./lbs.
- Motor dimensions may vary with motor manufacturer.
- Not for construction purposes.

NOTAS:

- Las bombas se transportarán con la descarga vertical superior como estándar. Para otras orientaciones, retirar los tornillos de la carcasa, rotar la descarga a la posición deseada, y apretar ⅜ - 16 tornillos a 12 pies/libras.
- TODAS las dimensiones en pulgadas.
- No para propósitos de construcción.

SPECIFICATIONS ESPECIFICACIONES

Capacities to:

1100 GPM (250 m³/hr) at
3500 RPM 775 GPM
(177 m³/hr) at 1750 RPM

Heads to:

525 feet THD (158 m) at
3500 RPM
130 feet THD (40 m) at
1750 RPM

Maximum working pressures to: 230 PSI
(15 bars)

Maximum temperatures to: 250°F (121°C)

All wetted components of AISI: Type 316L stainless steel material.

Rotation: Clockwise when viewed from motor end.

Enclosed impeller and replaceable wear ring: for high efficiency and maximum wear life.

Motor (close coupled):
NEMA standard JM shaft open drip-proof*, totally enclosed* and explosion-proof enclosures*, 60 Hz, 1750 or 3500 RPM.
Single phase ODP* (115/230 V) 1750 RPM, 1 - 5 HP.
Three phase ODP*. TEFC*/Exp. proof* (208 - 230/460 V).
3500 RPM, 2 - 100 HP
1750 RPM, 1 - 25 HP

NOTE: Overload protection must be provided. Contactor with overload for single phase or starter with heaters for three phase ordered separately.

Motor (frame mounted):

NEMA standard T-frame open drip-proof*, totally enclosed* and explosion-proof* (three phase only) enclosures 60 Hz, 1750 or 3500 RPM.

Single phase (115/230 V) 1750 RPM, 1 - 5 HP
Three phase (208 - 230/460 V)
3500 RPM, 3 - 125 HP
1750 RPM, 1 - 25 HP

NOTE: Overload protection must be provided. Contactor with overload for single phase or starter with heaters for three phase ordered separately.

Optional: Rigid carbon steel bedplate, sheet metal coupling guard designed to OSHA specifications and T.B. WOODS type "SC" spacer couplings.

* Premium efficiency where required by Department of Energy regulations.

Capacidades:

1100 GPM (105 m³/hr) a
3500 RPM 775 GPM (177
m³/hr) a 1750 RPM

Cargas:

525 pies THD (158 m) a
3500 RPM 130 pies THD (40
m) a 1750 RPM

Presión de trabajo máxima:

230 PSI (15 baras)

Temperatura máxima:

250°F (121°C)

Todos los componentes mojados de AISI: Material de acero inoxidable tipo 316L.

Rotación: En dirección de las agujas del reloj visto desde el extremo final del motor.

Impulsor encerrado y anillo de desgaste reemplazable: para alta eficiencia y máxima durabilidad.

Motor (acople cerrado):
Eje a prueba de goteo* JM estándar NEMA, totalmente encerrado* y recintos a prueba de explosión*, 60 Hz, 1750 ó 3500 RPM.
Unifásicos ODP (115/230 V) 1750 RPM, 1 - 5 HP
Trifásicos ODP. TEFC/a prueba de explosión (208 - 230/460 V).

3500 RPM, 2 - 100 HP
1750 RPM, 1 - 25 HP

NOTA: Se debe de proporcionar protección térmica contra sobrecarga. Contactor con protección térmica contra sobrecarga para unifásicos o arrancadores con calentadores para trifásicos se piden por separado.

Motor (armazón montado): Armazón abierto T a prueba de goteo* estándar NEMA, totalmente encerrado* y recintos a prueba de explosión* (trifásicos solamente) 60 Hz, 1750 ó 3500 RPM.

Unifásicos (115/230 V) 1750 RPM, 1 - 5 HP.

Trifásicos (208 - 230/460 V) 3500 RPM, 3 - 125 HP
1750 RPM, 1 - 25 HP

NOTA: Se debe de proporcionar protección térmica contra sobrecarga. Contactor con protección térmica contra sobrecarga para unifásicos o arrancadores con calentadores para trifásicos se piden por separado.

Opcional: Fundación rígida de acero al carbono, guarda acople de metal laminado diseñado según las especificaciones OSHA y acoples del espaciador T.B. WOODS tipo "SC".

* Eficacia superior donde se requiera por el Ministerio de regulaciones de la Energía.

TYPICAL APPLICATIONS APLICACIONES TÍPICAS

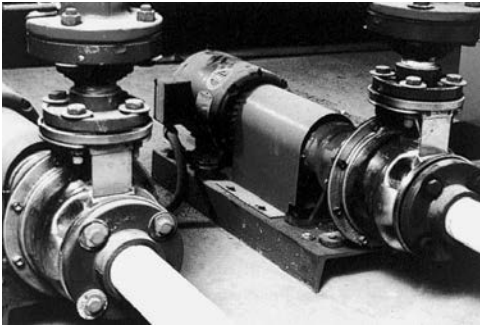

**HVAC,
Calefacción,
Ventilación y
Aire Acondicio-
nado**

Specifically designed for all traditional cast iron or bronze fitted water and low grade corrosive services.

- Water circulation
 - Booster systems
 - Liquid transfer
 - HVAC pump replacements
 - General service pumping
- *Circulación de Agua*
 - *Aumento de presión*
 - *Transferencia de líquidos*
 - *Reemplazos para bombas HVAC*
 - *Bombeo de servicios generales*

Diseñada específicamente para todos los servicios de agua de hierro fundido o recubiertas de bronce y servicios corrosivos de bajo grado.

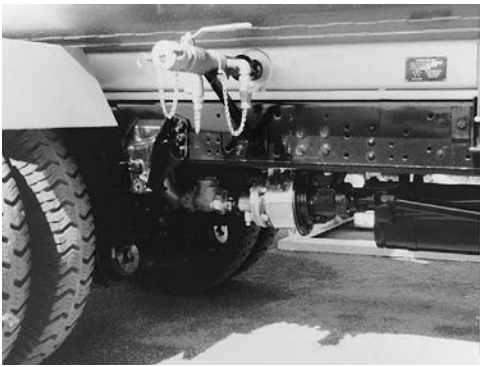

**Water truck,
Camión
cisterna**



**PCB washer,
Arandela PCB**

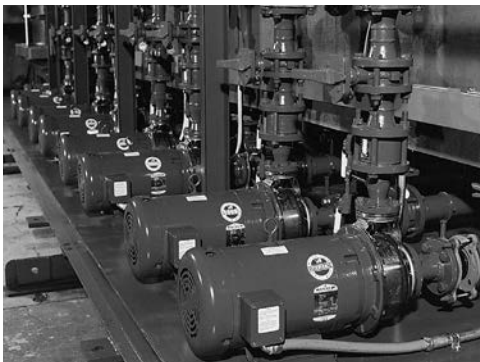

**Tubing washer,
Arandela de
tubería**

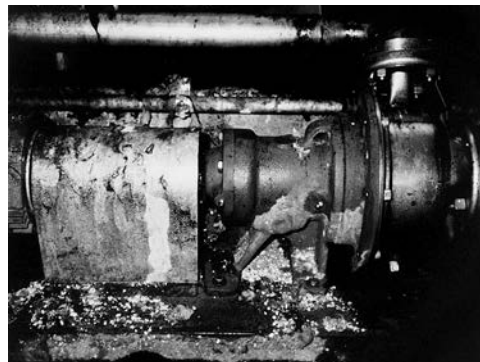

**Textile dyes,
Colorantes
textiles**



**Reverse
osmosis,
Ósmosis
invertida**

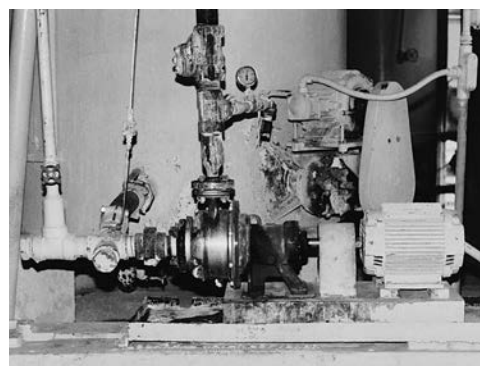

**Boiler feed,
Alimentación
de caldera**

NOTES
NOTAS

Xylem |'zīləm|

- 1) The tissue in plants that brings water upward from the roots;
- 2) a leading global water technology company.

We're a global team unified in a common purpose: creating innovative solutions to meet our world's water needs. Developing new technologies that will improve the way water is used, conserved, and re-used in the future is central to our work. We move, treat, analyze, and return water to the environment, and we help people use water efficiently, in their homes, buildings, factories and farms. In more than 150 countries, we have strong, long-standing relationships with customers who know us for our powerful combination of leading product brands and applications expertise, backed by a legacy of innovation.

For more information on how Xylem can help you, go to www.xylem.com

Xylem |'zīləm|

- 1) El tejido en las plantas que hace que el agua suba desde las raíces;
- 2) una compañía líder global en tecnología en agua.

Somos un equipo global unido por un propósito común: crear soluciones innovadoras para satisfacer las necesidades de agua de nuestro mundo. Desarrollar nuevas tecnologías que mejorarán la manera en que se usa, se conserva y se reutiliza el agua en el futuro es un aspecto crucial de nuestra labor. Transportamos, tratamos, analizamos y retornamos el agua al medio ambiente, y ayudamos a las personas a usar el agua de manera eficiente, en sus casas, edificios, fábricas y campos. Desde hace mucho tiempo y en más de 150 países, tenemos relaciones sólidas con clientes que nos conocen por nuestra potente combinación de marcas de producto líderes y conocimientos de aplicación, con el respaldo de nuestro legado de innovación.

Para obtener más información, visite [xylem.com](http://www.xylem.com).



Xylem Inc.
2881 East Bayard Street Ext., Suite A
Seneca Falls, NY 13148
Phone/Teléfono: (800) 453-6777
Fax: (888) 322-5877
www.gouldswatertechnology.com

Goulds is a registered trademark of Goulds Pumps, Inc. and is used under license.
Goulds es una marca registrada de Goulds Pumps, Inc. utilizada con permiso.
© 2016 Xylem Inc. BSSH R3 August (Agosto) 2016